

SCADAPack

6103 Power Supply Module

Version: 3.10.1

Date: November 2021

Document Number: 250515



Table of Contents

1	Legal Information	5
2	Technical Support	6
3	Safety Information	7
4	About the Book	10
5	About the 6103 Power Supply Module	13
6	Cybersecurity	15
7	Hardware Overview	17
	7.1 Input Power.....	18
	7.2 Outputs.....	18
	7.3 Protection Summary.....	18
8	Installation	19
	8.1 ATEX and IECEx Requirements.....	19
	8.2 Mounting the 6103 Power Supply Module.....	20
	8.3 Layout Guidelines.....	21
	8.4 Connecting I/O Modules.....	22
	8.4.1 Precautions	25
	8.4.2 Cabling Guidance.....	25
	8.4.3 Attaching Intermodule Cables	27
9	Field Wiring	30
	9.1 Wiring Screw-Termination Connectors.....	31
	9.2 Termination Connectors.....	32
	9.3 Fusing.....	33
10	Diagnostics	34
	10.1 LEDs	34
11	Maintenance	35
12	Specifications	36
	12.1 General.....	36
	12.2 Power Supply.....	36

13	Standards and Certifications.....	38
14	ATEX, IECEx, and UKCA Information.....	40

1 Legal Information

The information provided in this documentation contains general descriptions and/or technical characteristics of the performance of the products contained herein. This documentation is not intended as a substitute for and is not to be used for determining suitability or reliability of these products for specific user applications. It is the duty of any such user or integrator to perform the appropriate and complete risk analysis, evaluation and testing of the products with respect to the relevant specific application or use thereof. Neither Schneider Electric nor any of its affiliates or subsidiaries shall be responsible or liable for misuse of the information contained herein. If you have any suggestions for improvements or amendments or have found errors in this publication, please notify us.

No part of this document may be reproduced in any form or by any means, electronic or mechanical, including photocopying, without express written permission of Schneider Electric.

All pertinent state, regional, and local safety regulations must be observed when installing and using this product. For reasons of safety and to help ensure compliance with documented system data, only the manufacturer should perform repairs to components.

Trademarks

Schneider Electric, ClearSCADA, EcoStruxure, Modbus, RemoteConnect, SCADAPack, Telepace, and Trio are trademarks and the property of Schneider Electric SE, its subsidiaries and affiliated companies. All other trademarks are the property of their respective owners.

Address

Schneider Electric Systems USA

Process Automation SCADA & Telemetry
38 Neponset Avenue, Foxboro, Massachusetts 02035 USA
Direct Worldwide: +1 (613) 591-1943
Email: telemetrysolutions@se.com
Toll Free within North America: +1 (888) 267-2232
www.se.com



© 2021 Schneider Electric Systems USA Inc.
All rights reserved.

2 Technical Support

Questions and requests related to any part of this documentation can be directed to one of the following support centers.



Technical support: Americas, Europe, Middle East, Asia

Available Monday to Friday 8:00 am – 6:30 pm Eastern Time

	Check our FAQs	Explore our extensive knowledge database and FAQ videos to find answers quickly: https://se.com/faq
	Email us	Save time by emailing us your inquiry and an expert will contact you: supportTRSS@se.com Send us an email anytime.
	Call us	Need someone to provide some technical support? <ul style="list-style-type: none"> • Toll free within North America: 1-888-226-6876 • Direct Worldwide: +1-613-591-1943

Technical support: Australia/New Zealand (Pacific)

Available Monday to Friday 8:00 am - 5:00 pm Australian Eastern Standard Time

	Check our FAQs	Explore our extensive knowledge database and FAQ videos to find answers quickly: https://se.com/faq
	Email us	Save time by emailing us your inquiry and an expert will contact you: techsupport.pz@se.com Send us an email anytime.
	Call us	Need someone to provide some technical support? <ul style="list-style-type: none"> • Inside Australia: 13 73 28 (13 SEAU) • Inside New Zealand: 0800 652 999

3 Safety Information

Important information

Read these instructions carefully, and look at the equipment to become familiar with the device before trying to install, operate, or maintain it. The following special messages may appear throughout this documentation or on the equipment to warn of potential hazards or to call attention to information that clarifies or simplifies a procedure.



The addition of this symbol to a Danger or Warning safety label indicates that an electrical hazard exists, which will result in personal injury if the instructions are not followed.



This is the safety alert symbol. It is used to alert you to potential personal injury hazards. Obey all safety messages that follow this symbol to avoid possible injury or death.

⚠ DANGER
DANGER indicates a hazardous situation which, if not avoided, will result in death or serious injury.
⚠ WARNING
WARNING indicates a hazardous situation which, if not avoided, can result in death or serious injury.
⚠ CAUTION
CAUTION indicates a hazardous situation which, if not avoided, can result in minor or moderate injury.
NOTICE
NOTICE is used to address practices not related to physical injury.

Please note

Electrical equipment should be installed, operated, serviced, and maintained only by qualified personnel. No responsibility is assumed by Schneider Electric for any consequences arising out of the use of this material.

A qualified person is one who has skills and knowledge related to the construction, installation, and operation of electrical equipment and has received safety training to recognize and avoid the hazards involved.

Before you begin

Do not use this product on machinery lacking effective point-of-operation guarding. Lack of effective point-of-operation guarding on a machine can result in serious injury to the operator of that machine.

WARNING

EQUIPMENT OPERATION HAZARD

- Verify that all installation and set up procedures have been completed.
- Before operational tests are performed, remove all blocks or other temporary holding means used for shipment from all component devices.
- Remove tools, meters, and debris from equipment.

Failure to follow these instructions can result in death or serious injury.

Follow all start-up tests recommended in the equipment documentation. Store all equipment documentation for future reference.

Test all software in both simulated and real environments.

Verify that the completed system is free from all short circuits and grounds, except those grounds installed according to local regulations (according to the National Electrical Code in the U.S.A, for instance). If high-potential voltage testing is necessary, follow recommendations in equipment documentation to help prevent accidental equipment damage.

Operation and adjustments

The following precautions prevail:

- Regardless of the care exercised in the design and manufacture of equipment or in the selection and ratings of components, there are hazards that can be encountered if such equipment is improperly operated.
- It is sometimes possible to misadjust the equipment and thus produce unsatisfactory or unsafe operation. Always use the manufacturer's instructions as a guide for functional adjustments. Personnel who have access to these adjustments should be familiar with the equipment manufacturer's instructions and the machinery used with the electrical equipment.
- Only those operational adjustments actually required by the operator should be accessible to the operator. Access to other controls should be restricted to prevent unauthorized changes in operating characteristics.

Acceptable use

WARNING

UNACCEPTABLE USE

Do not use SCADAPacks or I/O modules as an integral part of a safety system. These devices are not safety products.

Failure to follow these instructions can result in death or serious injury.

CAUTION

EQUIPMENT OPERATION HAZARD

When devices are used for applications with technical safety requirements, the relevant instructions must be followed.

Use only Schneider Electric software or approved software with Schneider Electric hardware products.

Failure to follow these instructions can result in minor or moderate injury.

4 About the Book

Audience

WARNING

UNINTENDED EQUIPMENT OPERATION

The application of this product requires expertise in the design and programming of control systems. Only persons with such expertise are allowed to program, install, alter, and apply this product.

Follow all local and national safety codes and standards.

Failure to follow these instructions can result in death or serious injury.

This manual is written for people who need to install, troubleshoot or maintain the 6103 power supply module. These individuals are typically:

- Systems Engineers
- Commissioning Engineers
- Maintenance Technicians

Document scope

This manual describes:

- The physical design of the 6103 power supply module, including detailed hardware specifications
- Installation and wiring for the 6103 power supply module
- Diagnostics capabilities on the 6103 power supply module
- Maintenance recommendations for the 6103 power supply module

Validity note

This document is valid for:

- SCADAPack x70 firmware version 9.6.1 and earlier
- SCADAPack RemoteConnect configuration software version 3.9.1 and earlier

Related documents

Use this manual with the other manuals included in your SCADAPack x70 documentation set. The table below describes the manuals available in the documentation set.

Folder	Manual	Content
--------	--------	---------

Getting Started	Getting Started	<ul style="list-style-type: none"> • The SCADAPack x70 family of products available in this release • The basic steps to get your SCADAPack x70 device operational • Where to get more information about configuring, monitoring and managing your SCADAPack x70 device
SCADAPack Software Installation	SCADAPack Software Installation	<ul style="list-style-type: none"> • Hardware and software requirements • Installation procedures • Accessing help • Troubleshooting guidance
Hardware Manuals	The hardware manual for your SCADAPack x70 device	<ul style="list-style-type: none"> • Installation, wiring and addressing information • Diagnostics capabilities • Maintenance recommendations • Hardware specifications
Configuration Manuals	SCADAPack RemoteConnect Configuration Software	<ul style="list-style-type: none"> • Setting up and managing projects for your SCADAPack x70 device
	PC Communication Settings -SCADAPack CommDTM	<ul style="list-style-type: none"> • Setting up communications between SCADAPack RemoteConnect and your SCADAPack x70 device
	SCADAPack x70 Configuration	<ul style="list-style-type: none"> • Configuring SCADAPack x70 device operation
	Porting Guide for SCADAPack E to SCADAPack RemoteConnect	<ul style="list-style-type: none"> • Moving from SCADAPack E to SCADAPack RemoteConnect • Locating SCADAPack E Configurator features in SCADAPack RemoteConnect • Locating SCADAPack Workbench features in SCADAPack RemoteConnect • Compatibility chart
	Porting Guide for Telepace to SCADAPack RemoteConnect	<ul style="list-style-type: none"> • Moving from Telepace to SCADAPack RemoteConnect • Tutorial for creating a project • Compatibility chart
Technical	SCADAPack	<ul style="list-style-type: none"> • USB, serial and IP communications

Reference Manuals	Communication Interfaces Technical Reference	<ul style="list-style-type: none"> • Mobile communications • Dialup modem communications
	SCADAPack Operations Technical Reference	<ul style="list-style-type: none"> • The SCADAPack x70 device file system • Command line operations • Diagnostics operations • Telnet server operations • FTP server operations
	SCADAPack SCADA Protocols Technical Reference	<ul style="list-style-type: none"> • DNP3 protocol support • Modbus protocol support • IEC 60870-5-104 protocol support
Logic Programming Manuals	SCADAPack Logic Programming Overview	<ul style="list-style-type: none"> • The differences between EcoStruxure Control Expert (Unity Pro) and the SCADAPack x70 Logic Editor environment • Key programming concepts • Basic procedures needed to use the SCADAPack x70 Logic Editor
	SCADAPack Function Blocks Technical Reference	<ul style="list-style-type: none"> • The custom SCADAPack x70 function blocks that are available for developing IEC 61131-3 applications
	Using EFB Toolkit with SCADAPack x70	<ul style="list-style-type: none"> • Using the Schneider Electric EFB Toolkit with SCADAPack x70 devices and SCADAPack RemoteConnect configuration software
Security Administrator Manuals	SCADAPack Security Administrator	<ul style="list-style-type: none"> • Configuring security on your SCADAPack x70 device
	SCADAPack Security Technical Reference	<ul style="list-style-type: none"> • Security standards • Security overview • DNP3 Secure Authentication • Diagnostics • Attack vectors and requirements

5 About the 6103 Power Supply Module

The 6103 power supply module provides operating power for SCADAPack x70 devices and I/O modules. The 5 Vdc output powers the modules.

Input power is typically a 12 or 24 Vdc power source from either a conventional or battery backed power supply.

The 6103 power supply module uses cool running, transformer isolated, switch-mode technology for high efficiency and reliability. The 5 Vdc output is isolated from the input.

The 6103 power supply module can be cascaded to provide the necessary power capacity for any size of system.

This module differs from the 5103 power supply in that the 6103 power supply:

- Provides input and output connectors for 20-pin I/O bus connections and 16-pin I/O bus connections
- Does not include a battery charger
- Does not provide a 24 Vdc output



Connections

I/O modules include a short intermodule cable for connecting to a SCADAPack or to another I/O module. For information about the maximum number of I/O modules supported, see the hardware manual for your SCADAPack. For details on connecting I/O modules, see [Attaching Intermodule Cables](#)^[27].

Removable screw-termination connectors are provided for connecting the input power to the 6103 power Supply. For details on wiring input and output connectors, see [Field Wiring](#)^[30].

6 Cybersecurity

Cybersecurity is a branch of network administration that addresses attacks on or by computer systems and through computer networks that can result in accidental or intentional disruptions. The objective of cybersecurity is to help provide increased levels of protection for information and physical assets from theft, corruption, misuse, or accidents while maintaining access for intended users.

No single cybersecurity approach is adequate. Schneider Electric recommends a defense-in-depth approach. This approach layers the network with security features, appliances, and processes. The basic components of this approach are:

- Risk assessment: A systematic security analysis of the environment and related systems.
- A security plan built on the results of the risk assessment
- A multi-phase training campaign
- Network separation and segmentation: Physical separation of the control network from other networks, and the division of the control network itself into segments and security zones.
- System Access Control: Controlling access to the system with firewalls, authentication, authorization, and other software means, and traditional physical security measures such as video surveillance, fences, locked doors and gates, and locked equipment cabinets.
- Device hardening: The process of configuring a device against communication-based threats. Device hardening measures include disabling unused network ports, password management, access control, and the disabling of all unnecessary protocols and services.
- Network monitoring and maintenance: An effective defense-in-depth campaign requires continual monitoring and system maintenance to meet the challenge of new threats as they develop.
- See Security Considerations in the Security Technical Reference manual

Contact us

For more information, refer to the Schneider Electric Cybersecurity Support Portal at <http://www.se.com/b2b/en/support/cybersecurity/overview.jsp>.

Additional Resources

Schneider Electric Recommended Cybersecurity Best Practices
<https://www.se.com/ww/en/download/document/CS-Best-Practices-2019-340/>

Industrial Control Systems Cyber Emergency Response Team (ICS-CERT)
<https://ics-cert.us-cert.gov>

ICS-CERT Recommended Practices
<https://ics-cert.us-cert.gov/Recommended-Practices>

Center for Internet Security (CIS) Top 20 Critical Security Controls
<https://www.cisecurity.org/cybersecurity-best-practices>

FBI Cyber Crime

<https://www.fbi.gov/investigate/cyber>

Guide to Industrial Control Systems (ICS) Security

<https://www.nist.gov/publications/guide-industrial-control-systems-ics-security>

WaterISAC Water Security Network

<https://www.waterisac.org>

7 Hardware Overview

For ease of wiring and maintenance, external connections are terminated on removable connectors. If you need to remove the I/O module cover for any reason, first carefully consider the following information.

WARNING

UNINTENDED EQUIPMENT OPERATION

Evaluate the operational state of the equipment being monitored or controlled by the SCADAPack or the I/O module before removing power.

Failure to follow these instructions can result in death or serious injury.

WARNING

ELECTRICAL HAZARD

Remove power from the I/O module before removing the I/O module cover.

Failure to follow these instructions can result in death or serious injury.

NOTICE

STATIC ELECTRICITY DAMAGE

The electronics inside the I/O module can be damaged by static electricity. If you need to remove the I/O module cover, wear an anti-static wrist strap that is connected to ground. Failing to follow this step can cause intermittent or total loss of I/O module operation and will void the warranty.

Failure to follow these instructions can result in equipment damage.

For complete hardware specifications, see [Specifications](#)^[36].

For more information see:

- [Input Power](#)^[18]
- [Outputs](#)^[18]
- [Protection Summary](#)^[18]

7.1 Input Power

WARNING

HAZARD OF ELECTRIC SHOCK

Remove power from all devices before connecting or disconnecting inputs or outputs to any terminal or installing or removing any hardware.

Failure to follow these instructions can result in death or serious injury.

Input power is connected to the removable terminal block. The applied voltage is generally from a 12...24 Vdc isolated power supply. Voltages from 11...30 Vdc can be used.

7.2 Outputs

There is one shared 5 Vdc, 2 Amp output available on both downstream (right side) IO expansion connectors.

7.3 Protection Summary

Over-voltage protection

Over voltage may occur on cables that extend from a cabinet to a remote device or another cabinet. Results can include corrupted data carried on the cable or damage to devices connected to that cable. Following the guidelines below may reduce the severity and frequency of such events. It is highly recommended that end users determine the proper protection for their industry, application, and environment.

NOTICE

POWER SUPPLY LOSS OF FUNCTION

Use an external fuse, as specified in the manual.

Failure to follow these instructions can result in equipment damage.

The Power Input is protected against surges and reverse polarity connections. Input voltages up to 36 Vdc can be applied without damage. Fuses on the input power are recommended. See [Fusing](#)^[33].

8 Installation

WARNING

EXPLOSION HAZARD

THESE DEVICES ARE OPEN-TYPE DEVICES THAT ARE TO BE INSTALLED IN AN ENCLOSURE WITH TOOL REMOVABLE COVER OR DOOR, SUITABLE FOR THE ENVIRONMENT.

Failure to follow these instructions can result in death or serious injury.

WARNING

EXPLOSION HAZARD

DO NOT DISCONNECT WHILE THE CIRCUIT IS LIVE OR UNLESS THE AREA IS FREE OF IGNITABLE CONCENTRATIONS.

Failure to follow these instructions can result in death or serious injury.

The following sections describe specific aspects of installing the power supply module.

See:

- [ATEX and IECEx Requirements](#)^[19]
- [Mounting the 6103 Power Supply Module](#)^[20]
- [Layout Guidelines](#)^[21]
- [Connecting Modules](#)^[22]

8.1 ATEX and IECEx Requirements

The information in this topic applies when the unit is being used for ATEX and IECEx applications.

Specific conditions of use

Before installing the equipment, consider the instructions in the warning message below.

⚠ WARNING**EXPLOSION HAZARD**

Only install this equipment under the following conditions:

Specific Conditions of Use

- The equipment shall only be used in an area of not more than pollution degree 2, as defined in IEC/EN 60664-1.
- The equipment shall be installed in an enclosure that is only tool accessible and that provides a degree of protection not less than IP 54 in accordance with IEC/EN IEC 60079-0.
- Transient protection shall be provided that is set at a level not exceeding 140% of the peak rated voltage value at the supply terminals to the equipment.

Failure to follow these instructions can result in death or serious injury.

8.2 Mounting the 6103 Power Supply Module

The 6103 power supply module is mounted on the 7.5 x 35 x 1 mm (0.3 x 1.4 x 0.04 in) DIN rail and then connected to the system I/O Bus.

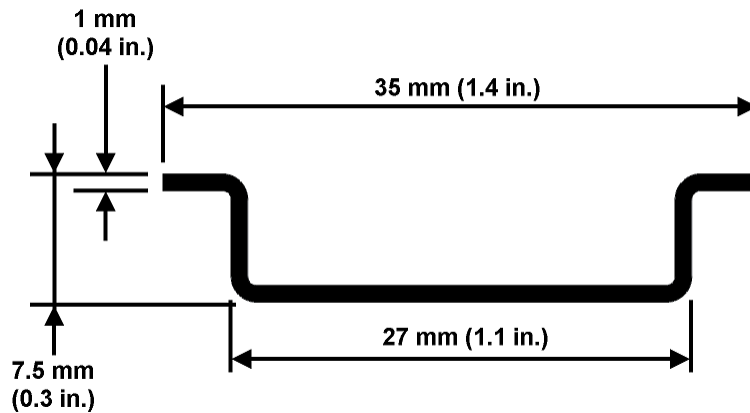

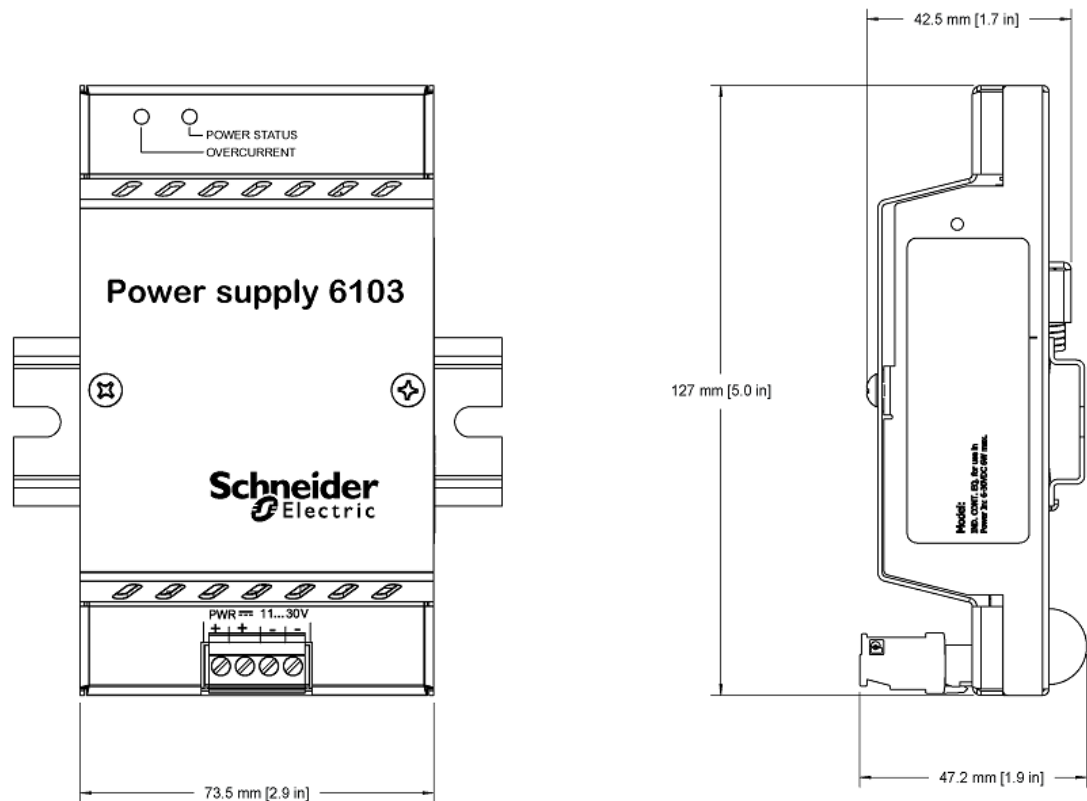

Follow these guidelines for mounting modules:

- DIN rails install horizontally or vertically. Where possible install DIN rails horizontally. Modules are easier to install on horizontal rails. Cooling is optimal when installed horizontally.
- Mount modules tightly together on the rail, to avoid straining the intermodule cable. The spacing dimples on the sides of the modules should touch.

⚠ WARNING

ELECTRICAL HAZARD

Remove power from the I/O module before mounting it on a DIN rail.

Failure to follow these instructions can result in death or serious injury.

8.3 Layout Guidelines

When additional I/O or power is required by the system, I/O expansion modules or 5103 and 6103 power supply modules can be used in combination with the controller. There are several guidelines to keep in mind when adding modules to your SCADAPack x70 control system.

Module location

The 5103 and 6103 modules supply power to the modules that are downstream from it. I/O

modules that are placed to the left of the power supply are powered by the previous controller or power supply. I/O modules that are placed to the right of the power supply are powered by that power supply.

Connect the 6000 series modules first and then connect any 5000 series modules. The 6103 power supply module can be mounted before and after any IO module. The 5103 power supply module needs to be mounted after any 6000 series I/O modules. The 5103 power supply module can be mounted before and after any 5000 series I/O module.

You can add modules as follows:

- If you are using only 5000 series I/O modules:
 - Connect the 5000 series modules directly to the controller until additional power is needed
 - Connect a 6103 or 5103 module followed by additional 5000 series I/O modules and power supply modules, as needed
- If you are using 5000 and 6000 series I/O modules:
 - Connect the 6000 series modules first and then follow the rules for connecting any 5000 modules
 - The 5103 power supply module can only be placed after the 6000 series modules

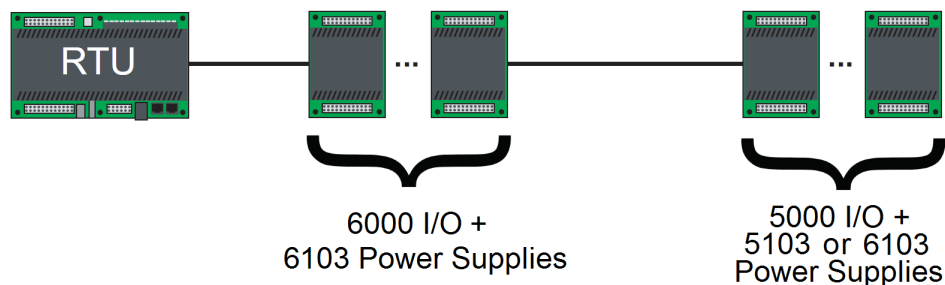

8.4 Connecting I/O Modules

The topics in this section describe how to attach I/O modules to a SCADAPack, or to another I/O module.

The 6103 supports both 16 conductor and 20 conductor inter-module cables on the upstream (left side) and downstream (right side) of the module.

- 20 conductor cables support 6000 series modules, the SCADAPack 4xx and the SCADAPack 5xx
- 16 conductor cables support 5000 series modules, the SCADAPack 3xx and other legacy SCADAPacks

The 6103 provides a convenient transition from 6000 series modules to 5000 series modules.

The connectors are two different sizes:

- 20-pin connectors mate with 20-pin cables
- 16-pin connectors mate with 16-pin cables

NOTICE**UNINTENDED EQUIPMENT OPERATION**

Do not attempt to insert the 16-pin cable into a 20-pin connector.

Failure to follow these instructions can result in equipment damage.

NOTICE**UNINTENDED EQUIPMENT OPERATION**

Do not attempt to use both the 16-pin and 20-pin connectors on the input or output side of the 6103 power supply.

Modules must be connected in series, not in parallel.

Failure to follow these instructions can result in equipment damage.

Three examples of how the 6103 can be used are shown in the following figures:

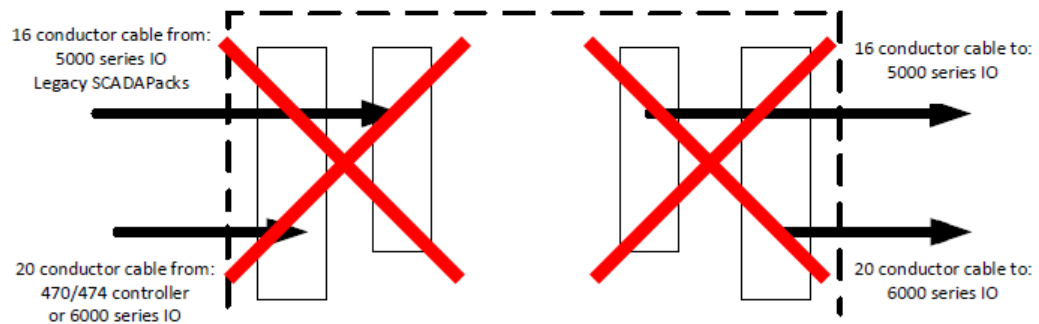
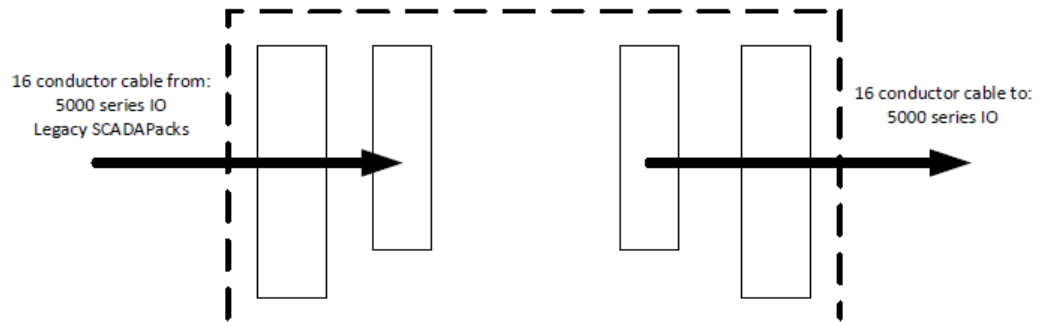
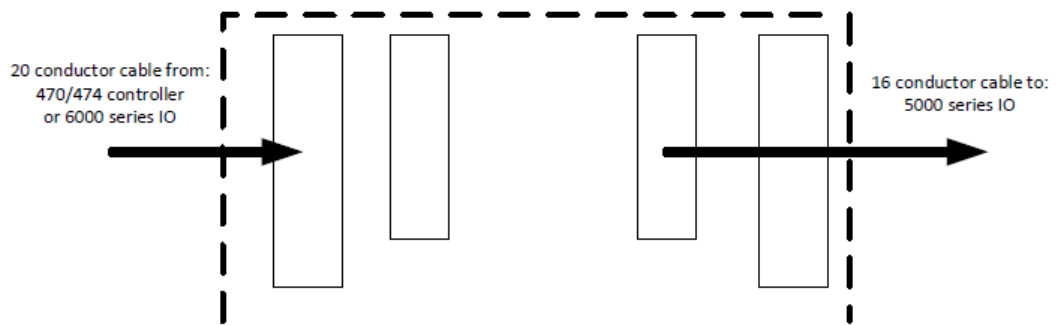
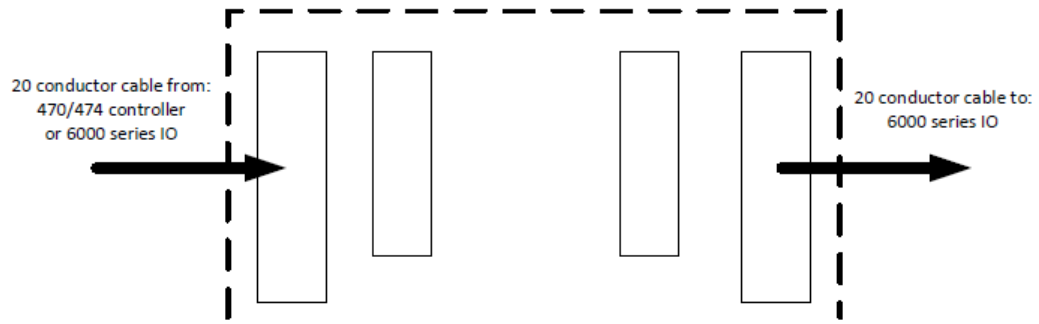

Modules must be connected in series, not in parallel.

Before [attaching intermodule cables](#)^[27], read the [Precautions](#)^[25] and the [Cabling Guidance](#)^[25].

8.4.1 Precautions

Before connecting I/O modules:

- Confirm that the power supply is rated for the total number of modules in the system. Some I/O modules, such as those with analog outputs, require an additional DC power supply to operate. See [Specifications](#)^[36] for details.
- Confirm that the intermodule cables you are using are less than the maximum total cable length. See [Maximum Intermodule Cable Length](#)^[27].
- Review the recommendations below to help avoid static electricity damage.

NOTICE

STATIC ELECTRICITY DAMAGE

Static electricity damage can cause intermittent or total loss of equipment operation. To help avoid static electricity damage:

- Wear an anti-static wrist strap that is connected to ground if you need to remove the device cover.
- Use the shortest length intermodule cable that is practical. This helps to minimize voltage drops and interference from electrical noise.
- Keep the intermodule cable away from electrical noise sources such as inductive load switching and variable frequency drives.
- If you are using a shielded cable, connect the shielding wire on the intermodule cable to a convenient chassis ground point. There is a small hole in the I/O module for grounding the shielding wire.
- Do not install intermodule cables in the same cable tray or in parallel with field wiring. Intermodule cables can cross field wiring at 90° if necessary.

Failure to follow these instructions can result in equipment damage.

8.4.2 Cabling Guidance

This topic summarizes the rules for connecting I/O modules to SCADAPack x70 devices. These rules apply to the following SCADAPack I/O modules:

- 6601 input output module
- 6602 HART module
- 6607 input output module
- 5304 analog output module
- 5405 digital input module
- 5410 high speed counter input module
- 5414 digital input module
- 5415 relay output module

- 5505 RTD input module
- 5506 analog input module
- 5606 input output module
- 5607 input output module

Using only 5000 series I/O modules

If you are using only 5000 series I/O modules with a SCADAPack x70 device, connect the 5000 series module directly to the SCADAPack using a 20-pin to 16-pin adapter cable (sold separately, see the SCADAPack Part Ordering List manual).

Using 5000 and 6000 series I/O modules

If you are using a combination of 5000 series I/O modules and 6000 series I/O modules with a SCADAPack x70 device, connect a 6000 series module to the SCADAPack first, followed by any other 6000 series modules. Then connect the 5000 series modules.

SCADAPack x70 devices and 6000 series modules provide a 20-pin I/O bus connector while 5000 series modules provide a 16-pin connector. Use the 20-pin to 16-pin adapter cable (sold separately, see the SCADAPack Part Ordering List manual) to transition from a 20-pin connector to a 16-pin connector.

As an alternative to 20-pin to 16 pin adapters, the 6103 power supply module can provide a convenient transition from 6000 series modules to 5000 series modules.

NOTICE

UNINTENDED EQUIPMENT OPERATION

Do not attempt to use both the 16-pin and 20-pin connectors on the input or output side of the 6103 power supply.

Modules must be connected in series, not in parallel.

Failure to follow these instructions can result in equipment damage.

General guidance

- Use the shortest length intermodule cable that is practical. This helps to minimize voltage drops and interference from electrical noise.
- Keep the intermodule cable away from electrical noise sources such as inductive load switching and variable frequency drives.
- If you are using a shielded cable, connect the shielding wire on the intermodule cable to a convenient chassis ground point. There is a small hole in the I/O module for grounding the shielding wire.
- Install intermodule cables in separate cable trays from field wiring, and not in parallel with field wiring. Intermodule cables can cross field wiring at 90° if necessary.

Intermodule cables

When determining the location of your I/O modules, review the following information about shielded intermodule cables and maximum intermodule cable length.

Shielded intermodule cables

Shielded intermodule cables have a foil and braid shielding. Intermodule cables longer than 30 cm (12 in) are shielded for physical protection and for isolation from electrical noise. The shielding is connected to a terminal lug at one end of the cable.

When using a shield for an intermodule cable, fasten the shield only to the module that is closest to the SCADAPack. Connect the shield to the enclosure using the self-tapping screw provided.

You can use up to 3 shielded intermodule cables. The total length of all cables can not exceed 1.82 m (75 in).

Maximum intermodule cable length

I/O modules ship with a short intermodule cable that is used to connect I/O modules to a SCADAPack or to another I/O module.

The maximum total intermodule cable length in a single system is 1.82 m (72 in). This length restriction does not include the short intermodule cable supplied with the I/O module. Schneider Electric offers several cable lengths that can be combined to reach the 1.82 m (72 in) limit.

Keep the following in mind:

- The highest power consumption modules need to be to closest to the controller or power supply with 6000 series modules first, followed by 5000 series modules due to connector limitations
- A combined run of 1.5 m (60 in) of expansion cables and modules needs to be followed by a power supply.
- 1.14 m (45 in) and 1.82 m (72 in) expansion cables need to be followed by a power supply
- The maximum number of power supply modules, not including the controller, is 2
- A 30 cm (12 in) or a 76 cm (30 in) cable is typically used to connect modules on separate DIN rails

To purchase additional intermodule cables, contact your Schneider Electric representative.

8.4.3 Attaching Intermodule Cables

This topic describes how to attach an intermodule cable between a SCADAPack and an I/O module. Follow the same steps to connect two I/O modules.

⚠ WARNING**UNINTENDED EQUIPMENT OPERATION**

Evaluate the operational state of the equipment being monitored or controlled by the SCADAPack or the I/O module before applying or removing power.

Failure to follow these instructions can result in death or serious injury.

⚠ WARNING**ELECTRICAL HAZARD**

The I/O bus does not support live-swapping.

Remove power from the SCADAPack and the I/O module before removing the cover.

Failure to follow these instructions can result in death or serious injury.

NOTICE**STATIC ELECTRICITY DAMAGE**

Static electricity damage can cause intermittent or total loss of equipment operation.

Always wear an anti-static wrist strap that is connected to ground when you remove the device cover.

Failure to follow these instructions can result in equipment damage.

5410 High Speed Counter Input Module Considerations

NOTICE**UNEXPECTED COUNTER READINGS**

Do not disconnect a 5410 high speed counter input module while the module and SCADAPack are powered.

Do not remove power from a 5410 high speed counter input module while the SCADAPack is powered and communicating with the module.

Failure to follow these instructions can result in unexpected counter readings.

Power off the SCADAPack before connecting or disconnecting the inter-module cable to the 5410 high speed counter input module.

Power off the SCADAPack and 5410 high speed counter input module at the same time. Use a common power supply input for the RTU and I/O modules.

To attach intermodule cables

1. Power down each SCADAPack and I/O module that you are connecting.
2. Remove the cover from the device if required to access the intermodule cable.
3. Press one end of the intermodule cable firmly into the I/O bus connector on the SCADAPack.

SCADAPack x70 devices and 6000 series modules provide a 20-pin I/O bus connector while 5000 series modules provide a 16-pin connector. Use the 20-pin to 16-pin adapter cable (sold separately, see the SCADAPack Part Ordering List manual) to transition from a 20-pin connector to a 16-pin connector.

The connectors on intermodule cables are keyed so they can only be inserted in one direction. If the connector does not push easily into the I/O bus connector, reverse it and try again.

4. Press the other end of the intermodule cable firmly into the I/O bus connector on the I/O module.

The illustration below shows a connected intermodule cable. While the size and shape of your devices may differ and the color of the connectors may be different, the location of the intermodule cable is the same on each device type.

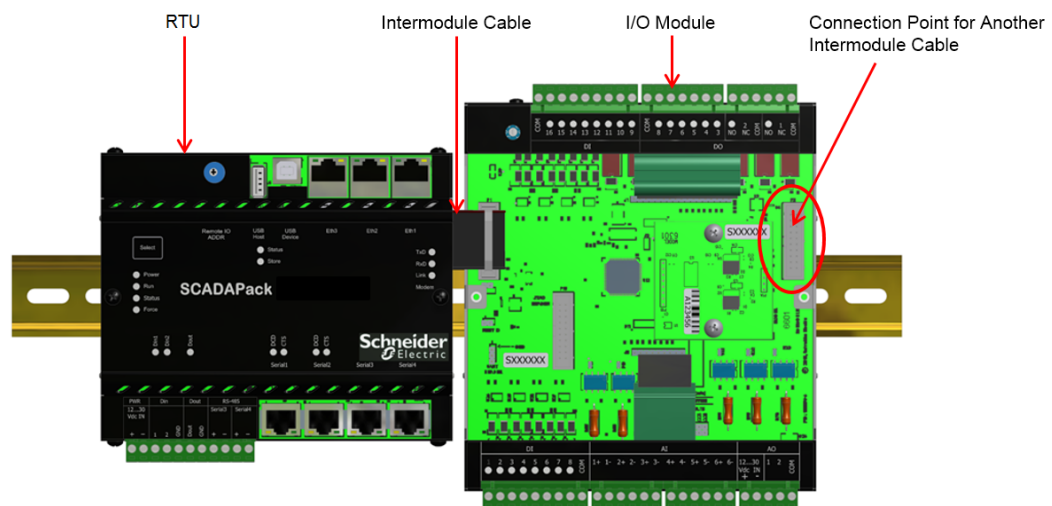

5. Replace the cover on the I/O module and on the SCADAPack if it was removed, taking care to check that the ribbon cable connecting the I/O module is not pinched.
6. Apply power to the SCADAPack.

You are now ready to configure the I/O module.

9 Field Wiring

Field wiring attaches to the field wiring terminal blocks on each module.

WARNING

ELECTRICAL HAZARD

Remove power from all devices before connecting or disconnecting inputs or outputs to any terminal or installing or removing any hardware.

Failure to follow these instructions can result in death or serious injury.

NOTICE

UNINTENDED EQUIPMENT OPERATION

Do not exceed the maximum voltage specified for each input or output. See the Specifications topic for the maximum voltage.

Failure to follow these instructions can result in equipment damage.

Field wiring guidelines

Follow these guidelines when planning for field wiring:

- When modules are installed in a Class I Division 2 area, power, input and output (I/O) wiring needs to be in accordance with Class I, Division 2 wiring methods (article 501-4(b) of the National Electrical Code, NFPA 70) and in accordance with the authority having jurisdiction.
- Arrange the modules so field wiring is accessible.
- Field wiring termination connectors are removable. Leave enough slack in the wiring for the connector to be removed.
- Arrange the modules and wiring so the status LEDs are visible.
- Keep modules switching loads away from communication controllers and analog input modules.
- Route low-level signals separate from high-level and AC power signals.
- No bonding is usually required by Electrical Safety Standards between modules carrying primary power and AC ground, since these modules are certified as components to be installed within an enclosure thereby limiting access by unauthorized personnel. Consult individual module manuals for special bonding instructions should they be required.
- Consult individual module manuals for the connection of external fuses should they be required, in particular by primary voltage carrying modules. Install where required.

The 6103 power supply module accommodates DC inputs. Observe signal polarity when using DC inputs.

For more information see:

- [Wiring Screw-Termination Connectors](#) ^[31]
- [Termination Connectors](#) ^[32]
- [Fusing](#) ^[33]

9.1 Wiring Screw-Termination Connectors

The connectors support solid or stranded wires 2.5...0.2 mm² (12...28 AWG).

Use copper conductors only, 300 V, min. 105 °C (221 °F).

WARNING

UNINTENDED EQUIPMENT OPERATION

Evaluate the operational state of the equipment being monitored or controlled by the SCADAPack or the I/O module before wiring screw-termination connectors.

Failure to follow these instructions can result in death or serious injury.

WARNING

ELECTRICAL HAZARD

Remove power from all modules and devices before servicing.

Failure to follow these instructions can result in death or serious injury.

To wire a connector

1. Use a slotted screwdriver to loosen the termination screw.
2. Insert the stripped wire into the connector so that the bared wire is located under the screw.

Verify that the bared wire is placed fully within the connector, as illustrated below.

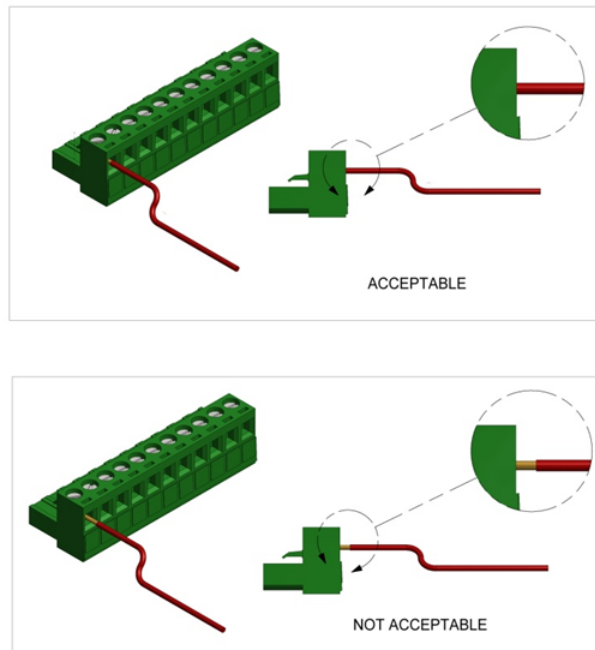

3. Apply 0.5 N•m (4.5 lb-in) torque to tighten the screw so the wire is held firmly in place.

9.2 Termination Connectors

Field wiring for the model 6103 power supply terminates on a 4 pole connector. The table below lists the termination connector.

Terminal	Function
1 and 2	+ Input power (see Input Power ^[18])
3 and 4	- Input power (see Input Power ^[18])

⚠ WARNING

HAZARD OF ELECTRIC SHOCK

Remove power from all devices before connecting or disconnecting inputs or outputs to any terminal or installing or removing any hardware.

Failure to follow these instructions can result in death or serious injury.

Controller, modem and I/O modules use screw termination style connectors for termination of field wiring. They accommodate solid or stranded wires from 2.5...0.2 mm² (12...28 AWG).

The connectors are removable. This allows module replacement without disturbing the field wiring. Leave enough slack in the wiring for the connector to be removed.

Remove power before servicing unit.

To remove the connector

- Pull the connector upward from the board while applying even pressure to both ends of the connector.

To install the connector

1. Line up the pins on the module with the holes in the connector aligning the pins properly.
2. Push the connector onto the pins while applying even pressure to both ends on the connector.

9.3 Fusing

An external fuse is required on the power supply input. The recommended fuse is a 1.6 A fast acting fuse.

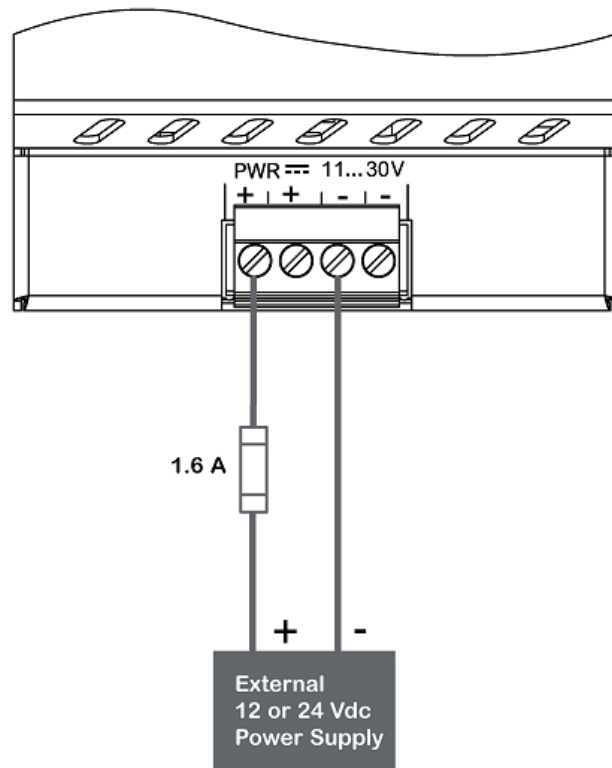

10 Diagnostics

Input and output modules provide LEDs that indicate the status of inputs and outputs. There are also a number of actions you can take to determine the cause of unexpected activities.

For more information see:

- [LEDs](#) ^[34]

10.1 LEDs

There are two diagnostic LEDs. Under normal operating conditions both LEDs will be green.

Refer to the table below for a description of the LED operation.

LED	Green	Red	Off
POWER STATUS	Input Power is present. The 5 Vdc output (right side) is present.	Input Power is not present. The left side cable is connected.	Input Power is not present. The left side cable is not connected.
OVERCURRENT	The output current is below the rated maximum.	The 2 A maximum output current is exceeded. The threshold current is approximately 2.1 A.	Input Power is not present

11 Maintenance

This module requires no routine maintenance. If the module is not functioning correctly, contact [Technical Support](#)^[6] for more information and instructions for returning the module for repair.

12 Specifications

Disclaimer: Schneider Electric reserves the right to change product specifications without notice. If you have questions about any of the specifications, contact [Technical Support](#)^[36].

For more information, see:

- [General](#)^[36]
- [Power Supply](#)^[36]

12.1 General

Item	Specification
Environment	-40...70 °C (-40...158 °F) operating temperature -40...85 °C (-40...185 °F) storage temperature 5...95% relative humidity, non-condensing Pollution Degree 2, Installation Category I, Indoor use
Elevation	3,000 m (9,842 ft)
Terminations	2.5...0.2 mm ² (12...28 AWG) solid or stranded
Packaging	Corrosion-resistant and RoHS compliant clear zinc-plated steel with black enamel paint
Dimensions	73.5 mm (2.9 in.) wide 127 mm (5.0 in.) high 47.2 mm (1.9 in.) deep
Mechanical Shock	IEC 61131-2 ½ sine, 15 ms, 15 g
Vibration	IEC 61131-2 5...8.4 Hz: Amplitude controlled, 7.0 mm (0.28 in) peak-to-peak 8.4...150 Hz: Acceleration controlled, 1.0 g peak

12.2 Power Supply

Item	Specification
------	---------------

Connector	Removeable, 4-pin
Input Voltage	11...30 Vdc, Class 2 or SELV LPS
Input Power	13 W (Vin = 24 V, 2 A output)
Input Isolation	250 Vac / 350 Vdc maximum to RTU logic and chassis
Input Protection	Over-voltage protection against voltages up to 36 V and reverse polarity
Output Voltage	5.1 V +/- 0.05 V
Output Current	2 A maximum
Visual Indicators	<p>POWER STATUS LED</p> <ul style="list-style-type: none"> • Red: 5 V input present upstream and Input Power is not present • Green: 5 V output present and Input Power present • Off: 5 V input not present upstream and Input Power not present <p>Over Current LED</p> <ul style="list-style-type: none"> • Red: Output current exceeds 2.1 A • Green: Output current below rated maximum • Off: Input Power not present

13 Standards and Certifications

Introduction

SCADAPacks are designed to comply with the relevant standards and rules for electrical equipment in an industrial automation environment.

Industrial Standards

Requirements specific to the SCADAPack functional characteristics, immunity, robustness, and safety:

- IEC/EN 61131-2
- CSA 22.2 No. 61010-1-12 and CSA 22.2 No. 61010-2-201
- UL 61010-1 and UL 61010-2-201

CE Marking Compliance

- For the latest information regarding product compliance with European Directives for CE marking, refer to the EU Declaration of Conformity issued for your product at www.se.com
- For the latest information regarding product compliance with RoHS, WEEE directives and REACH regulation, visit the Schneider Electric **Check a Product** portal at <https://checkaproduct.se.com>

Certification for Classified Ex Area

- Hazardous locations Class I, Division 2, Groups A, B, C, and D, T4 and Class I, Zone 2, IIC T4
- UL 121201, 9th Edition
- UL 61010-1, Edition 3. Revision Date 07/19/2019
- UL 61010-201, Edition 2, Issue Date 05/14/2018
- CSA C22.2 No. 213-17, 3rd Edition
- CSA C22.2 No. 61010-1-12, Edition 3, Revision Date 2018-11
- CSA C22.2 61010-2-201, Edition 2, Issue Date 02/2018
- **IECEx: Ex ec IIC T4 Gc**
- IEC 60079-0, Edition 7
- IEC 60079-7, Edition 5.1
- **ATEX, UKEX: II 3 G Ex ec IIC T4 Gc**
- EN IEC 60079-0:2018
- EN IEC 60079-7: 2015 +A1:2018

⚠ WARNING**EXPLOSION HAZARD**

THESE DEVICES ARE OPEN-TYPE DEVICES THAT ARE TO BE INSTALLED IN AN ENCLOSURE WITH TOOL REMOVABLE COVER OR DOOR, SUITABLE FOR THE ENVIRONMENT.

Failure to follow these instructions can result in death or serious injury.

⚠ WARNING**EXPLOSION HAZARD**

DO NOT DISCONNECT WHILE THE CIRCUIT IS LIVE OR UNLESS THE AREA IS FREE OF IGNITABLE CONCENTRATIONS.

AVERTISSEMENT – RISQUE D'EXPLOSION. NE PAS DÉBRANCHER PENDANT QUE LE CIRCUIT EST SOUS TENSION OU À MOINS QUE L'EMPLACEMENT NE SOIT EXEMPT DE CONCENTRATIONS INFLAMMABLES.

Failure to follow these instructions can result in death or serious injury.

Specific Countries

For Australia and New Zealand: ACMA requirements for RCM marking

For United States: FCC Part 15 Subpart B Class A

For UK: UKCA marking

For Eurasian Economic Union: EAC marking

14 ATEX, IECEx, and UKCA Information

For 6103 Power Supply Module (P/N TBUX297595)

⚠ WARNING











EXPLOSION HAZARD

Only install this equipment under the following conditions:

Specific Conditions of Use

- The equipment shall only be used in an area of not more than pollution degree 2, as defined in IEC/EN 60664-1.
- The equipment shall be installed in an enclosure that is only tool accessible and that provides a degree of protection not less than IP 54 in accordance with IEC/EN IEC 60079-0.
- Transient protection shall be provided that is set at a level not exceeding 140% of the peak rated voltage value at the supply terminals to the equipment.

Failure to follow these instructions can result in death or serious injury.

<p>TBUX297595 MODEL 6103 REYNOSA</p>	 S/N: 123456 DOM: yyww	 Refer to user manual: 250515 Revision: 2.7.1 https://se.com/6103	
 LISTED E184163			Power Input: 11...30 Vdc 13 W max (to be powered by a Class 2 power supply) Power Output: 5.1 Vdc, 2A max
- 40 °C ≤ Ta ≤ + 70 °C IND. CONT. EQ. FOR USE IN HAZ. LOC. Cl. I, Div. 2 GPs ABCD, T4, Cl. I Zone 2, IIC T4 Ex ec IIC T4 Gc UL 21 ATEX 2602X IECEx UL 21 .0092X UL21UKEX2241X 415 LEGGET DRIVE, SUITE 101 KANATA, ON K2K 3R1, CANADA			 Модуль расширения 
1050-0674 Rev1 PID 270849 MADE IN MEXICO			

Certified to the following Ex standards

- IEC 60079-0, Edition 7
- IEC 60079-7, Edition 5.1
- EN IEC 60079-0:2018
- EN IEC 60079-7: 2015 +A1:2018

Connection Terminal Blocks

- Screw connection terminal blocks: solid or stranded copper wires
2.5...0.2 mm² (12...28 AWG)
- Torque for screw connection terminal block connectors: 0.5 N•m (4.5 Lb-in)
- Minimum supply cable temperature rating: 105 °C (221 °F)

Technical support: Americas, Europe, Middle East, Asia
Available Monday to Friday 8:00am – 6:30pm Eastern Time

Toll free within North America
Direct Worldwide
Email

1-888-226-6876
+1-613-591-1943
supportTRSS@se.com

Technical support: Australia/New Zealand (Pacific)

Inside Australia
Inside New Zealand
Email

13 73 28 (13 SEAU)
0800 652 999
techsupport.pz@se.com

