



Modicon M262

IIoT-ready logic/motion controller for performance machines



Modicon

Discover Modicon

Industrial Edge control for IIoT

Modicon IIoT-native edge controllers manage complex interfaces across assets and devices or directly into the cloud, with embedded safety and cybersecurity. Modicon provides performance and scalability for a wide range of industrial applications up to high-performance multi-axis machines and high-available redundant processes.

Explore our offer

- Modicon HVAC Controllers
- Modicon PLC
- Modicon Motion Controllers
- Modicon PAC
- Modicon I/O
- Modicon Networking
- Modicon Power Supply
- Modicon Wiring
- Modicon Safety

Life Is On



Quick access to product information

Get technical information about your product

References

Modicon TM3
I/O expansion modules for Modicon controllers
Analog I/O modules

Number and type of channels	Input range	Output range	Resolution	Input format (mV)	Reference	Weight (kg)
2 voltage inputs	-15...+15 VDC 0...20 mA r.t. 20 mA	16.000 or 12.000 r.t. 4 sign	16.000 or 12.000	0VDC 0VDC	TM3AI2H TM3AI2HG	0.110 0.100
4 voltage inputs	-15...+15 VDC 0...20 mA r.t. 20 mA	16.000 or 12.000 r.t. 4 sign	16.000 or 12.000	0VDC 0VDC	TM3AI4 TM3AI4G	0.110 0.100
4 voltage or temperature inputs	-15...+15 VDC 0...20 mA r.t. 20 mA	16.000 or 12.000 r.t. 4 sign	16.000 or 12.000	0VDC 0VDC	TM3AI4T TM3AI4TG	0.110 0.100
4 differential temperature inputs	0...100 °C 0...100 °C 0...100 °C 0...100 °C	16.000 or 12.000 r.t. 4 sign	16.000 or 12.000	0VDC 0VDC	TM3AI4D TM3AI4DG	0.110 0.100
8 voltage inputs	-15...+15 VDC	16.000 or 12.000 r.t. 4 sign	16.000 or 12.000	0VDC 0VDC	TM3AI8 TM3AI8G	0.110 0.100

Share Price Global (English) My Products My Documents Partner Portal

Life Is On Schneider Electric

Search products, documents & more

PRODUCTS SOLUTIONS SERVICES SUPPORT ABOUT US

All products Industrial Automation and Control PLC, PAC and Dedicated Controllers Distributed Input/Output (I/O) Modules Modicon TM3

View all Modicon TM3

TM3AI2H

Module TM3 - 2 analog inputs high resolution

Show more characteristics >

Related Software >

Add to My Products Compare

Product Datasheet User guide Catalogue CAD Document

Characteristics Documents and Downloads Technical FAQs Additional Information Dimensions Drawings >

Main

range of product Modicon TM3

product or component type Analog input module

range compatibility Modicon M251

Each commercial reference presented in a catalog contains a hyperlink. Click on it to obtain the technical information of the product:

- Characteristics, Dimensions and drawings, Mounting and clearance, Connections and schemas, Performance curves
- Product image, Instruction sheet, User guide, Product certifications, End of life manual

Find your catalog



- > With just 3 clicks, you can access the Industrial Automation and Control catalogs, in both English and French
- > Consult digital automation catalogs at [Digi-Cat Online](#)

Industrial Automation

General Catalog

- Publications, Selections, PLCs & PACs
- Books, Catalogs & Interfaces
- Signaling Devices
- HMI (Terminals and Industrial PC)
- Sensors & RFID System
- Motor Starters and Load Management
- Components for Motor Starters
- Variable Speed Drives & Soft Starters
- Motor Control & Robotics
- Interface, Measurement & Control Relays
- PLC, PAC & other Controllers

Publications, Selections, PLCs & PACs

Hardware 380

Product Selector

Library 360°

- Up-to-date catalogs
- Embedded product selectors, 360° pictures
- Optimized search by commercial references

Select your training



- > Find the right [Training](#) for your needs on our Global website
- > Locate the training center with the selector tool, using this [link](#)

Training and courses

Training by domain of expertise

- Electrical Installation and Safety
- Data Center
- Industrial Automation

Content

Modicon® M262

Logic/Motion controller – IIoT-ready for performance machines

<i>Introduction to EcoStruxure Machine</i>	page 2
<i>Selection guide: controllers for industrial machines</i>	page 4
<i>Machine automation</i>	pages 6 and 7

■ Presentation

□ Modicon M262, the IIoT-ready controllers for Logic & Motion machines	pages 8 and 9
□ Targeted applications	page 12
□ Embedded I/O	page 10
□ Extended I/O with modular I/O systems	page 10
□ Equipment	page 10
□ Performance	page 11
□ Certifications and Standards	page 11
□ Environmental characteristics	page 11
□ Supply characteristics	page 11
□ Programming	page 11
□ Housing	page 12
□ Connecting Modicon M262 controllers	
- to devices	page 12
- to the Modicon TM3 optimized I/O system	page 12
- to Modicon TM5 and Modicon TM7 High-performance I/O systems	page 13
- to Modicon TM5 and Modicon TM7 safety I/O systems	page 13
□ Embedded communication	page 14
□ Additional communication	page 15
□ Embedded Safety	page 15
■ <i>Selection guide: Modicon M262 controllers</i>	pages 16 and 17

■ Description

□ Modicon M262 Logic/Motion controllers	page 18
□ Modicon TMS Smart communication modules	page 18

■ References

□ Modicon M262 Logic/Motion controllers	page 19
□ Modicon TMS smart communication modules	page 19
□ Spare parts, accessories	page 19
□ Expansion modules	page 19

■ Tested Validated & Documented Architecture

□ Modicon M262 Logic controller	page 20
□ Modicon M262 Motion controller	page 21

■ Product reference index	page 22
--	---------

To be competitive in today's digital era, machine builders must be innovative. Smart machines, those that are better connected, more flexible, more efficient, and safe, are enabling machine builders to innovate in ways never before possible.

EcoStruxure, Schneider Electric's open, IoT-enabled architecture and platform, offers powerful solutions for the digital era. As part of this, EcoStruxure Machine brings powerful opportunities for machine builders and OEMs, empowering them to offer smart machines and compete in the new, digital era.

EcoStruxure Machine brings together key technologies for product connectivity and edge control on premises, and cloud technologies to provide analytics and digital services. EcoStruxure Machine helps you bring more innovation and added value to your customers throughout the entire machine life cycle.

Innovation at Every Level for Machines is full systems across three layers:

- Connected products
Our connected products for measuring, actuating, device level monitoring, and control adhere to open standards to provide unmatched integration opportunities and flexibility
- Edge Control
We are IIoT-ready with a proven set of tested and validated reference architectures that enable the design of end-to-end open, connected, and interoperable systems based on industry standards. Ethernet and OPC UA facilitates IT/OT convergence meaning machine builders reap benefits from web interfaces and cloud.

- Apps, Analytics & Services
Seamless integration of machines to the IT layer allows the collection and aggregation of data ready for analysis – for machine builders and end users alike this means increased uptime and the ability to find information faster for more efficient operations and maintenance.

These levels are completely integrated from shop floor to top floor. And we have cloud offers and end-to-end cybersecurity wrapped around.

EcoStruxure Machine makes it easier for OEMs/ machine builders to offer their customers smarter machines. The advent of smart machines is driven by the changing needs of end users:

- Evolving workforce
- Reducing costs
- Dynamic markets
- Shorter life cycles
- Prioritizing safety and cybersecurity

EcoStruxure Machine provides one solution for the whole machine life cycle:

- With Smart Design & Engineering the time to market is reduced by up to 30% using our automated engineering and the simulation capabilities
- During Commissioning & Operation of the machine, resources such as energy, material and loss can be improved, and with seamless integration to the IT world efficiency can be improved by up to 40%
- Smart Maintenance & Services reduces the time for corrective actions up to 50%

EcoStruxure™ Machine

Innovation At Every Level



* The Schneider Electric industrial software business and AVEVA have merged to trade as AVEVA Group plc, a UK listed company. The Schneider Electric and Life is On trademarks are owned by Schneider Electric and are being licensed to AVEVA by Schneider Electric.

Modicon M262

Logic/Motion controller – IloT-ready for performance machines
Controllers for industrial machines

Applications	Type	Logic controller		Logic/Motion controller		Motion controller
	Specification	For hardwired architectures	For performance-demanding applications	For modular and distributed architectures	IloT ready for performance machines	For automating machines/lines with 0 - 130 servo or robot axes
						
Performance		0.2 µs/inst	22 ns/inst	22 ns/inst	3...5 ns/inst	0.5...2 ns/inst
Memory		640 KB RAM, 2 MB Flash	64 MB RAM, 128 MB Flash	64 MB RAM, 128 MB Flash	192 MB RAM, 256 MB Flash	128 KB to 256 KB NV RAM 512 MB DDR2 to 1 GB DDR3L
Supply voltage		24 V --- or 100...240 V ~	24 V --- or 100...240 V ~	24 V ---	24 V ---	24 V ---
Communication fieldbus and networks	Embedded	<ul style="list-style-type: none"> ■ EtherNet/IP ■ RS 232/RS 485 serial link ■ USB mini-B programming port 	<ul style="list-style-type: none"> ■ Ethernet ■ CANopen (master) and SAE J1939 ■ 2 serial links ■ USB mini-B programming port 	<ul style="list-style-type: none"> ■ EtherNet/IP ■ CANopen (master) and SAE J1939 ■ Serial link ■ USB mini-B programming port 	<ul style="list-style-type: none"> ■ EtherNet/IP ■ Sercos III ■ Modbus TCP ■ Serial link ■ USB mini-B programming port 	<ul style="list-style-type: none"> ■ EtherNet/IP ■ Sercos III ■ CANopen ■ Profibus ■ Profinet ■ EtherCAT
	Optional	<ul style="list-style-type: none"> ■ 1 Serial Line 	<ul style="list-style-type: none"> ■ Ethernet ■ Profibus DP 	<ul style="list-style-type: none"> ■ Ethernet ■ Profibus DP 	<ul style="list-style-type: none"> ■ Ethernet ■ CANopen 	<ul style="list-style-type: none"> ■ CANopen ■ Profibus DP ■ RT-Ethernet
Embedded I/O	Input types	Up to 40 logic inputs Up to 2 analog inputs	Up to 24 logic inputs	–	4 fast digital inputs	Up to 20 digital inputs Up to 16 touch probe inputs Up to 4 interrupt inputs Up to 2 analog inputs
	Output types	Up to 16 relay outputs Up to 16 transistor outputs	Up to 16 transistor outputs	–	4 fast digital outputs	Up to 16 digital outputs Up to 2 analog outputs
Synchronized axes		–	–	–	Up to 16 synchronized axes	Up to 130 synchronized axes
Configuration software		EcoStruxure Machine Expert-Basic (1)	EcoStruxure Machine Expert (2)	EcoStruxure Machine Expert (2)	EcoStruxure Machine Expert (2)	EcoStruxure Machine Expert (2)
Compatible expansion I/O module ranges (consult the catalog)	Local I/O	● Modicon TM3 (DIA3ED2140109EN)	● Modicon TM3 (DIA3ED2140109EN)	● Modicon TM3 (DIA3ED2140109EN)	● Modicon TM3 (DIA3ED2140109EN)	–
	Remote I/O	● Modicon TM3 (DIA3ED2140109EN)	● Modicon TM3 (DIA3ED2140109EN)	● Modicon TM3 (DIA3ED2140109EN)	● Modicon TM3 (DIA3ED2140109EN)	–
	Distributed I/O on Ethernet	● Modicon TM3 (DIA3ED2140109EN)	● Modicon TM3 (DIA3ED2140109EN) ● Modicon TM5 (DIA3ED2131204EN)	● Modicon TM3 (DIA3ED2140109EN) ● Modicon TM5 (DIA3ED2131204EN)	● Modicon TM3 (DIA3ED2140109EN) ● Modicon TM5 (DIA3ED2131204EN) ● Modicon TM7 (DIA3ED2140405EN)	● Modicon TM5 (DIA3ED2131204EN)
	Distributed I/O on CANopen	–	● Modicon TM3 (DIA3ED2140109EN)	● Modicon TM3 (DIA3ED2140109EN)	● Modicon TM3 (DIA3ED2140109EN) ● Modicon TM5 (DIA3ED2131204EN) ● Modicon TM7 (DIA3ED2140405EN)	● Modicon TM3 (DIA3ED2140109EN) ● Modicon TM5 (DIA3ED2131204EN) ● Modicon TM7 (DIA3ED2140405EN)
	Distributed I/O on Sercos	–	–	–	● Modicon TM5 (DIA3ED2131204EN)	● Modicon TM5 (DIA3ED2131204EN)
	Distributed I/O on Modbus Serial Line	● Modicon TM3 (DIA3ED2140109EN)	● Modicon TM3 (DIA3ED2140109EN)	● Modicon TM3 (DIA3ED2140109EN)	● Modicon TM3 (DIA3ED2140109EN)	–
Safety I/O	⚠ Modicon TM3 (DIA3ED2140109EN)	⚠ Modicon TM3 (DIA3ED2140109EN)	⚠ Modicon TM3 (DIA3ED2140109EN)	⚠ Modicon TM3 (DIA3ED2140109EN) ⚠ Modicon TM5 (DIA3ED2131204EN) ⚠ Modicon TM7 (DIA3ED2140405EN)	⚠ Modicon TM5 (DIA3ED2131204EN) ⚠ Modicon TM7 (DIA3ED2140405EN)	
Controller range		Modicon M221/M221 Book	Modicon M241	Modicon M251	Modicon M262	LMC Eco, LMC Pro2
More details in catalog		DIA3ED2140106EN	DIA3ED2140107EN	DIA3ED2140108EN	DIA3ED2180503EN	DIA7ED2160303EN

(1) Formerly named SoMachine Basic.

(2) Formerly named SoMachine, EcoStruxure Machine Expert merges both former software ranges, SoMachine and SoMachine Motion.

Modicon M262

Logic/Motion controller – IIoT-ready for performance machines

Machine Automation

Machine Automation

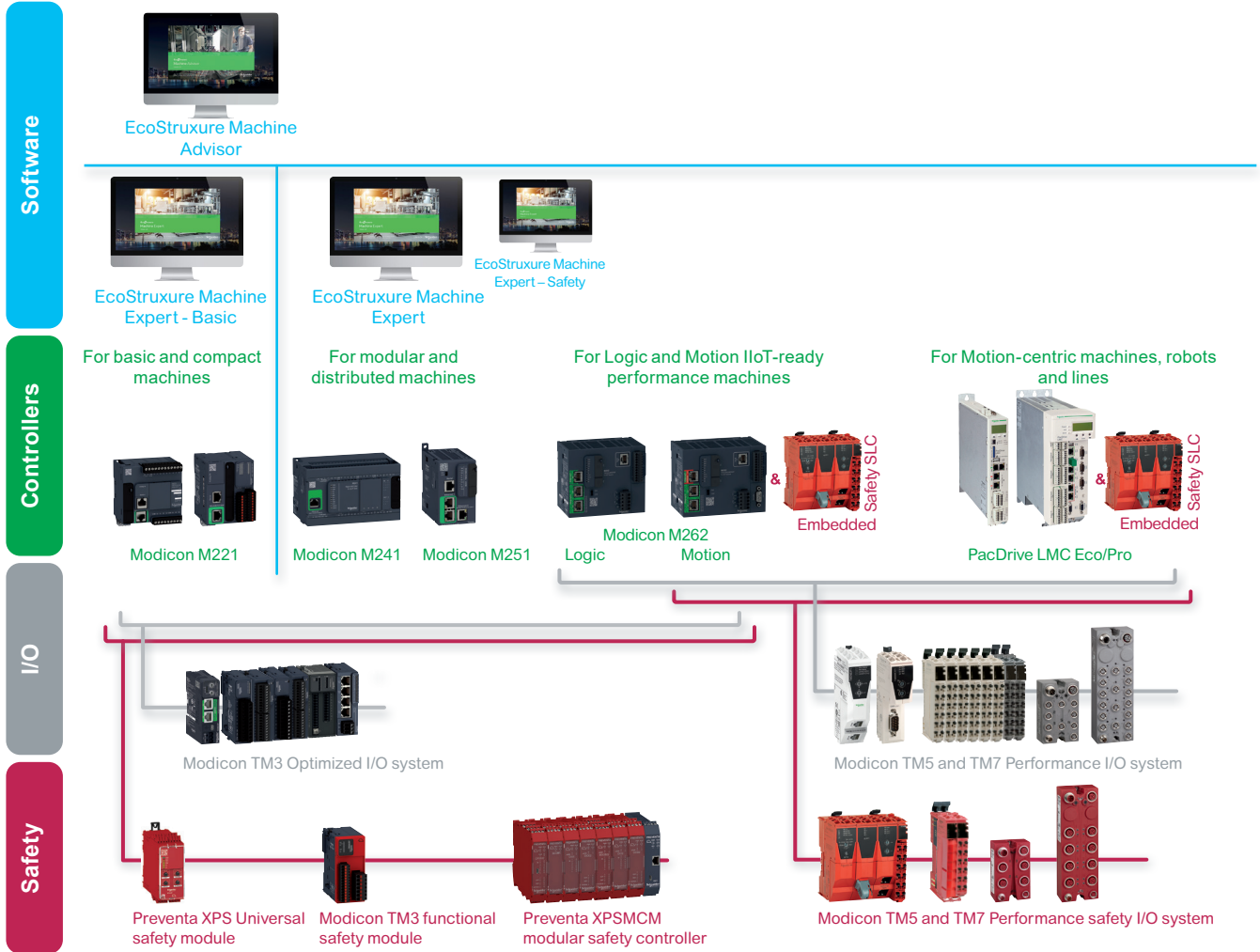

Machine control

> From basic to motion- and robot-centric machines with the PacDrive 3 offer, Modicon controllers and solutions bring a consistent and scalable response to achieving flexibility, performance, productivity and digitization.

The scalability and consistency of I/O ranges allow you to select the right offer depending on your needs

> Modicon TM3 Optimized I/O system for more compact and modular machines
 > Modicon TM5 for more performance-demanding machines, with Modicon TM7 for harsh environments; Both Performance I/O ranges (Modicon TM5 and TM7) allow safety functions to be implemented using the Modicon TM5CSLC safety logic controller

Embedded Safety provides holistic solutions to Modicon M262 and PacDrive LMC controllers, increasing overall safety demand in Machine Automation

> Preventa XPS Universal safety modules cover a wide range of safety functions, suitable for small applications with 4-5 safety functions, with diagnostic information provided to controllers via a single wire connection
 > Modicon TM3 safety functional modules are suitable for small applications covering E-Stop functions and diagnostics via TM3 bus
 > Preventa XPSMCM modular safety controllers are suitable for medium size applications with up to 20 safety functions and diagnostics via Modbus TCP, EtherNet/IP, EtherCAT, or Profinet

All these devices are managed within a single software, EcoStruxure Machine Expert, a powerful and collaborative engineering environment

> **EcoStruxure Machine Expert – Safety** optional add-on for programming safety logic controllers
 > **EcoStruxure Machine Expert – Basic** software for programming Modicon M221 logic controllers: an intuitive standalone environment accessible to basic skilled technicians
 > **EcoStruxure Machine Advisor** is a cloud-based services platform designed for machine builders to track machines in operation worldwide, monitor performance data and resolve exceptional events, while reducing support costs by up to 50%

Modicon M262

Logic/Motion controller – IIoT-ready for performance machines

Machine Automation

Machine Automation

Comprehensive Schneider offers for machine builders

- > Lexium servo drives, motors and robotics are designed to control applications ranging from a single independent axis up to high-performance synchronized multi-axis machines requiring high-speed and precise positioning and movements



- > The Lexium offer is designed for a broad range of motion-centric machines in applications such as [Packaging](#), [Material Handling](#), [Material Working](#), [Food and Beverage](#) and [Electronics](#)
- > Schneider Electric has developed Tested Validated & Documented Architectures (TVDA) applicable for generic machine control applications as well as for dedicated segment applications such as Packaging, Material Working, Material Handling, Hoisting, Pumping, or generic [Machine Control applications](#)

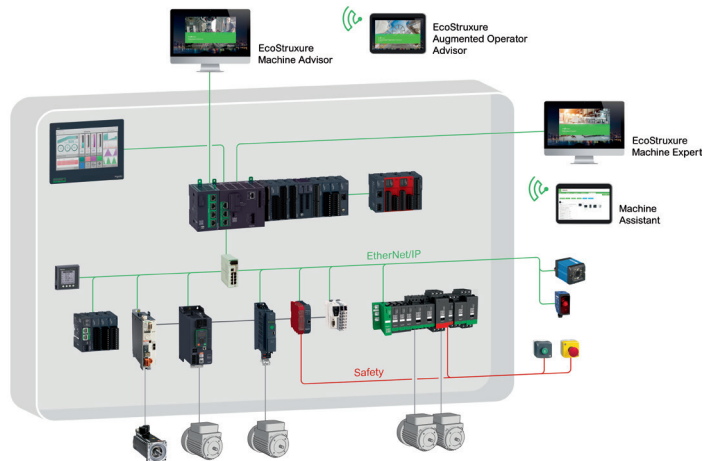

Choose Schneider Electric to help secure your investment and benefit from worldwide services at every step of your project

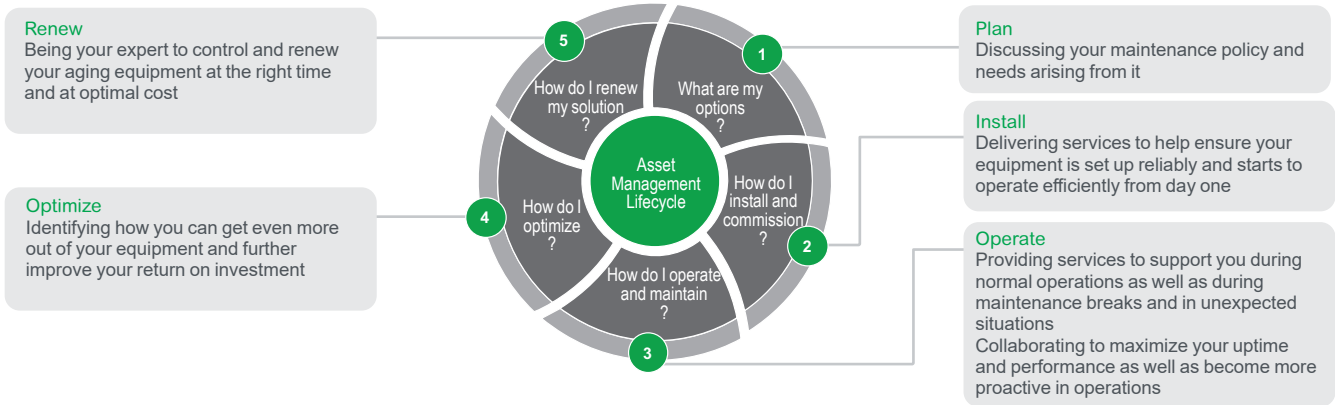

- > From planning and inception to modernization, we help ensure optimal technical and business performance. Our field service engineers combine 30+ years of manufacturer-level experience with the latest technology to bring innovation to every level of our offer and every step of your project.
- > Our machine control dedicated services empower you to maximize your business infrastructure and face increasingly stringent demands on productivity, safety, equipment availability and performance optimization.

Modicon M262

Logic/Motion controller – IIoT-ready for performance machines

General overview

Modicon M262, the IIoT-ready controller for logic and motion machines

As a Machine Builder, manufacturing machines with logic or motion control and moving into the Industry 4.0 era, you are looking for a controller with embedded cloud connectivity that offers cybersecurity capabilities and supports monitoring, analytics and predictive maintenance.

As the latest polyvalent controller for Logic and Motion with cloud protocols (MQTT(s), HTTP(s), JSON, OPC UA Client/Server) and encryption (TLS), the Modicon M262 is ready for you.

Modicon controllers are a key part of our EcoStruxure Machine that provides complete architectures from Connected Products, Edge Control to Apps, Analytics and services.

Modicon M262 controllers embed Industrial Internet of Things (IIoT) protocols and encryption to provide direct cloud connectivity and digital services.

Digitization

Integrate your machine in any cloud and on-premise environment

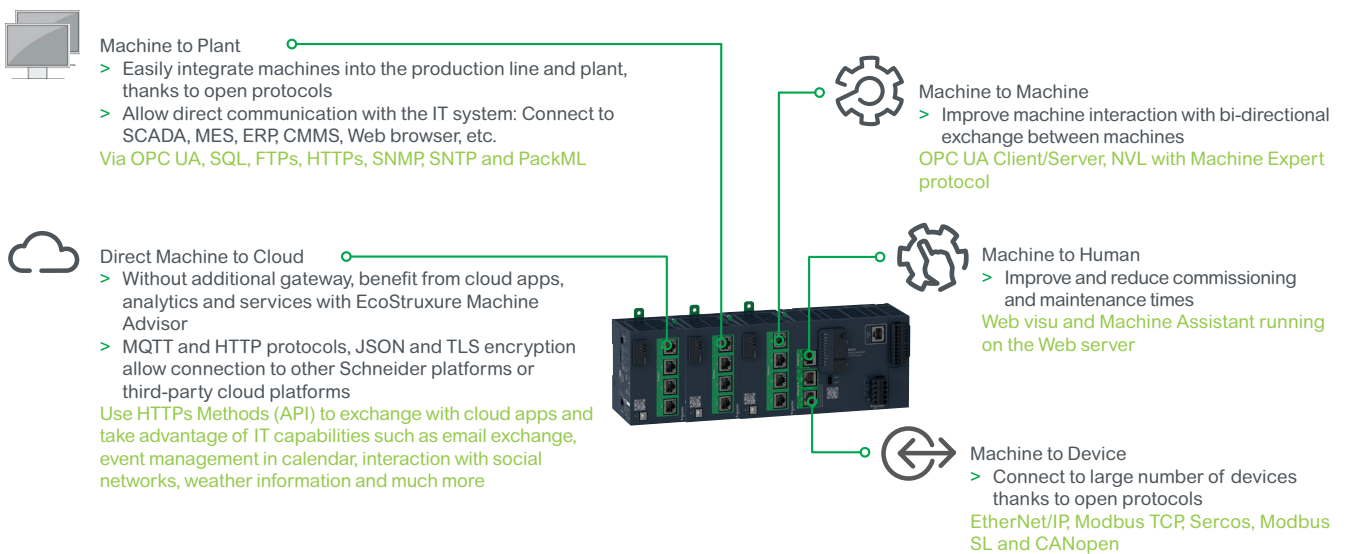

- > Structured networking with up to 5 separate Ethernet ports (2 embedded in the Modicon M262 and up to 3 additional ports with TMSES4) to allow easy integration into your plant, production line, ERP, MES, SCADA with open protocols like OPC UA, PackML or SQL

Flexibility and scalability

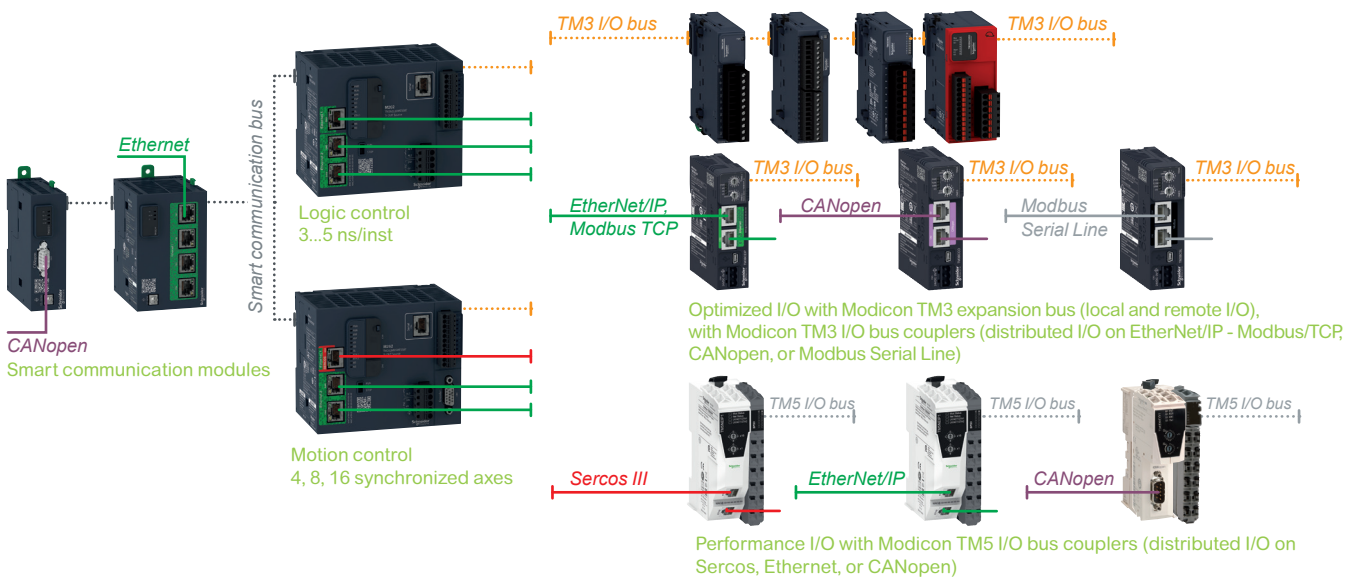

- > Scalable performance - Manage logic applications, synchronized motion, embedded safety and cloud connectivity in one controller
- > I/O system adjusted to your needs, Optimized (Modicon TM3) for just enough architecture, or Performance (Modicon TM5) with high resolution, hot swap capability, etc.

Modicon M262

Logic/Motion controller – IIoT-ready for performance machines

General overview

Modicon M262, the IIoT-ready controller for logic and motion machines

Efficiency

Through smart engineering design

Modicon M262 Motion controller, Optimized local I/O with Modicon TM3

Modicon TM5 safety logic controller, Modicon TM5 Sercos interface module, Modicon TM5 safety I/O, Modicon TM7 safety I/O

Harmony ST6W using EcoStruxure Machine Expert software, for WebVisu service

Optimized I/O with Modicon TM3: Distributed I/O on Ethernet with TM3 I/O bus coupler

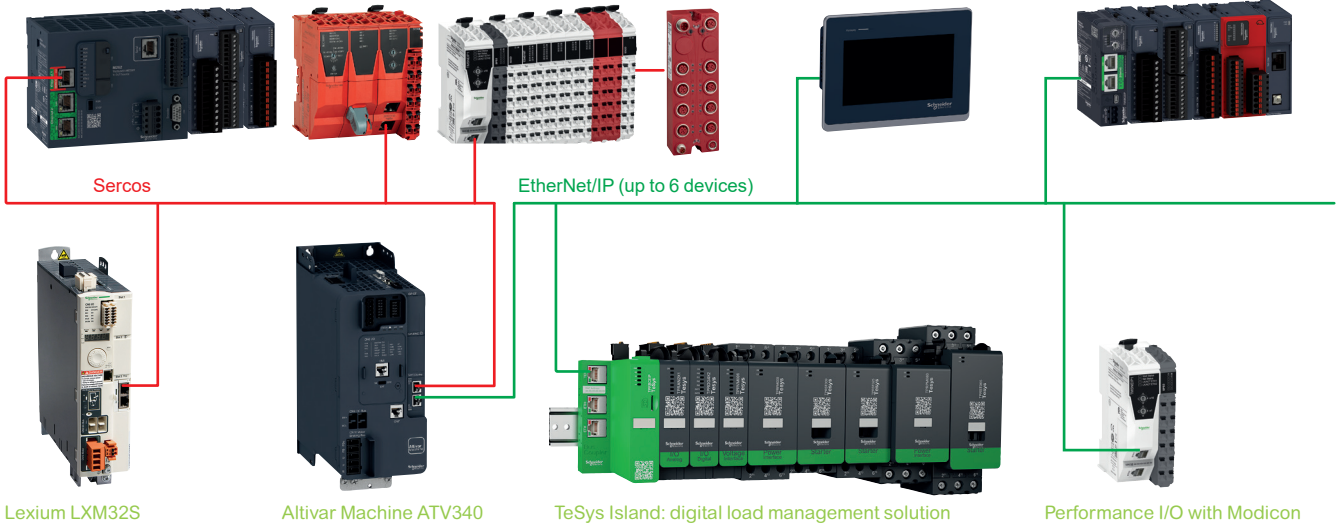

Lexium LXM32S

Altivar Machine ATV340

TeSys Island: digital load management solution

Performance I/O with Modicon TM5: Distributed I/O on Ethernet with TM5 interface module

- > Benefit from real-time automation fieldbus with Sercos for fast motion control, safety functions and openness to other devices
- > One cable simplifies the architecture and fieldbus wiring. Manage EtherNet/IP and Sercos devices on the same cable

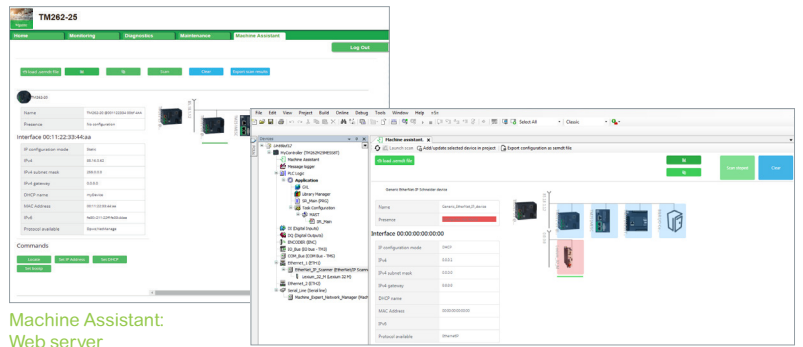

Machine Assistant: Web server

Machine Assistant: EcoStruxure Machine Expert

- > Simplified commissioning and diagnostics without software installation – “Machine Assistant”

Protection

Embedded safety and security functions: Help to protect people, machines, data and the environment



- > Meet safety regulations with embedded safety: Motion controller and safety logic controller
- > Cybersecurity, including encrypted communications, network separation, Achilles certification, user access/rights management, etc.
- > Green Premium certified, our ecolabel compliant with environmental regulations. Find more information on our [website](#)

Modicon M262

Logic/Motion controller – IIoT-ready for performance machines

Modicon M262 Logic/Motion controllers



Food & Beverage applications



Packaging applications



Material handling applications



Textile applications



Semiconductor



Hoisting applications

Presentation

The Modicon M262 Logic/Motion controller offer is designed for performance-demanding machines; M262 controllers are IIoT-ready (MQTT, HTTP, OPC UA, TLS, etc.) and combine logic, motion and safety control applications.

- > TM262L●●● for the logic control of multiple input and output arrangements
- > TM262M●●● for the motion control of up to 16 synchronized axes, embedding a safety control application according to SIL3

Targeted applications

Modicon M262 Logic/Motion controllers are the ideal solution for industrial control processes in many fields of application, including the following:

- > Food & Beverage: From compact to modular – complete automation solutions for food and beverage machinery including robotics
- > Packaging: Schneider Electric has automated more than 100,000 machines worldwide with benchmark Modicon controllers and PacDrive platforms
- > Material handling: Complete solutions far beyond basic technologies - from logic, motion and drive controllers to cartesian and delta picker solutions
- > Textile: Proven technology for automating high-speed processes in textile production
- > Hoisting: Proven architectures according to EN ISO 13849-1 and technology-specific function blocks enhance productivity in industrial and construction cranes
- > Semiconductor: A wide range of automation and digitization solutions enables machine builders to develop new machines and lines faster and with more flexibility
- > General purpose: For machines requiring IIoT embedded connectivity or encrypted communication

Embedded I/O

- > Modicon M262 Logic/Motion controllers embed 4 fast digital inputs and 4 fast digital outputs, connected to the controller via removable spring terminal blocks on the controller front face (1):
 - Input types:
 - Sink/Source, 24 VDC, 8.1 mA, filtered
 - Digital: Raise an event task in 20 μs on rising or falling edge or both, latch, capture position on encoder
 - Output types:
 - Source, 24 VDC, 50 to 200 mA, 3 μs
 - Fallback
 - All inputs and outputs have status LEDs.
- > Modicon M262 Motion controllers (TM262M●●●) embed an encoder input (SSI or incremental)
 - 5 VDC or 24 VDC configurable power supply, 150 mA
 - SSI 100 or 200 kHz, 5 VDC

Extended I/O with modular I/O systems

- > Modicon M262 Logic/Motion controllers can be combined with Modicon TM3, Modicon TM5 and Modicon TM7 offers, allowing:
 - An increased number of I/O: with the Modicon TM3 expansion module offer, in local and remote I/O configurations
 - Distributed I/O on communication networks:
 - Optimized distributed I/O islands on Ethernet, CANopen, Modbus Serial Line with Modicon TM3
 - Performance distributed I/O islands on Ethernet or Sercos III with Modicon TM5 and Modicon TM7

Equipment

Modicon M262 Logic/Motion controllers are equipped with:

- an integrated RTC
- a Run/Stop switch
- a NC alarm relay contact 24 VDC/2 A

(1) Removable spring terminal blocks are supplied with the controllers.



Modicon M262

Logic/Motion controller – IIoT-ready for performance machines

Modicon M262 Logic/Motion controllers

EtherNet/IP and Modbus/TCP devices				
Logic/Motion controller	EtherNet/IP Max. number of devices	RPI (ms)	Modbus/TCP Max. number of devices	EtherNet/IP + Modbus/TCP Max. number of devices
TM262L10	64	40	64	96
TM262L20	64	20	64	128
TM262M15	64	40	64	96
TM262M25	64	20	64	128
TM262M35	64	20	64	128

Sercos, synchronized axes, motion and one-cable devices						
Motion controller	No. of sync. axes	Sercos cycle time (ms)	Additional Sercos slaves	Total Sercos slaves	Additional EtherNet/IP slaves over Sercos	RPI (ms)
TM262M15	4	1	4	8	6	10
	4	2	12	16	6	10
	4	4	12	16	6	10
TM262M25	4	1	8	12	6	6
	8	2	8	16	6	6
	8	4	16	24	6	6
TM262M35	8	1	8	16	6	6
	16	2	8	24	6	6
	16	4	24	40	6	6



EcoStruxure Machine Expert software



[DIA3ED2180701EN](#)

Performance

- > The Modicon M262 Logic/Motion controllers embed a dual-core processor:
 - Core 1 is dedicated to manage program tasks and offers maximum resources for real-time execution of the application code.
 - Core 2 is dedicated to execute communication tasks, which then have no further impact on the application execution performance.
- > They have a minimum cycle time of 500 μs, a 256 MB RAM memory that can store data and applications (32 MB for applications) and a 1 GB Flash memory for application and data backup. A SD card (up to 32 GB) can also be used in addition to embedded memories.
- > Performance of Modicon M262 controllers: 3 to 5 ns/instruction

Certifications and standards

- Modicon M262 controllers meet the requirements of the following certifications:
 - CE, cULus HazLoc, RCM, EAC, Achilles L2, EU RO Mutual (Marine certification) (1)
- Modicon M262 controllers conform to the following standards:
 - UL 61010-1, -2-201
 - CSA C22.2 No. 61010-1, CSA C22.2 No. 61010-2-201, CSA C22.2 No. 213
 - ANSI/ISA 12-12-01
 - EN 61131-2

Environmental characteristics

- Ambient operating temperature:
 - Horizontal mounting: - 20...60 °C (-4...140 °F)
 - Vertical mounting: - 20...50 °C (-4...122 °F)
 - Flat mounting: - 20...45 °C (-4...113 °F)
- Storage temperature: - 40...85 °C (- 40...185 °F)
- Relative humidity: 5...95% (non-condensing)
- Operating altitude: 0...2000 m (0...6,562 ft)
- Storage altitude: 0...3000 m (0...9,842 ft)

Power supply characteristics

- Modicon M262 controllers are powered with a non-isolated 24 V DC power supply and have built-in overload protection.
- Voltage limit: 20.4... 28.8 V $\overline{\text{DC}}$
 - Immunity to micro-cuts (class PS-2): < 10 μs
 - Max. consumption of controller during operation is 82 W

Programming

- > EcoStruxure Machine Expert is the machine builder's solution software for developing, configuring and commissioning machine controllers such as Modicon M262 and the entire machine in a single software environment, including logic control, motion control, remote I/O systems, safety control, motor control, HMI design and related network automation functions.
- > This software environment covers the entire engineering life-cycle with:
 - Collaborative team work and version management
 - IIoT and standard libraries integration
 - Automatic testing (ETEST) and simulation
 - Code quality control (Machine Code Analysis)
 - Deployment and commissioning
 - Diagnostics and remote services
- > In addition, EcoStruxure Machine Expert interacts with various engineering tools via open interfaces.
 - IEC 61131-3 programming languages: Instruction List (IL), Ladder Diagram (LD), Function Block Diagram (FBD), Sequential Function Chart/Grafset (SFC), Structured Text (ST) and CFC (Continuous Function Chart)
 - Integrated fieldbus configurators
 - Expert diagnostic and debugging functions
 - Motion design, according to PLCopen Motion Control, as well as multiple capabilities for commissioning, maintenance and visualization

(1) Pending.

Modicon M262

Logic/Motion controller – I/O-ready for performance machines

Modicon M262 Logic/Motion controllers

Housing

- > With compact dimensions, Modicon M262 Logic/Motion controllers optimize the size of wall-mounted and floor-standing control system enclosures.
Format (w x d x h): 125 x 90 x 100 mm (4.92 x 3.54 x 3.93 in.)
- > Modicon M262 Logic/Motion controllers can be mounted on DIN rail (└┘) or panel (1).
- > A QR code, printed on the front face of controllers and smart communication modules, gives a link to the product's SE maintenance page and its unique serial number (S/N).
- > For easier identification in the field, the product's commercial reference is printed on the front of the controller.
- > A slot for an industrial memory card is available on the controller's front face: SD card up to 2 GB or SDHC card up to 32 GB. **TMASD** industrial SD memory cards are available for backing up and transferring applications, data logging and firmware updates.

Connecting a Modicon M262 controller to devices

- > Connecting a PC to the USB Mini-B isolated port for programming (with Machine Expert, FTP, HTTP and Modbus protocols)
- > Connecting of up to three smart communication modules via the smart communication bus, assembled by simple interlocking on the left-hand side of the controller. The smart communication bus embeds the power supply for the smart communication modules. Two types of smart communication module are available for CANopen and Ethernet connections.



- 1 TMSCO1 CANopen smart communication module
- 2 TMSES4 Ethernet smart communication module
- 3 M262 Logic/Motion controller

Maximum installation: a maximum of one TMSCO1 with two TMSES4 or three TMSES4 smart communication modules is allowed. TMSCO1 is always the last module on the left. Alternatively, a maximum of three TMSES4 smart communication modules can be connected.

Connecting a Modicon M262 controller to the Modicon TM3 I/O system

- > A TM3 I/O bus port located on the right-hand side of the Modicon M262 controller allows connection of any of the Modicon TM3 expansion modules for local or remote I/O configurations. Modicon TM3 can be also used in distributed architecture.
 - Local I/O: 7x TM3 expansion modules (max. configuration)
 - Remote I/O: + 7x TM3 remote modules (equals 14x TM3 modules: 7x local + 7x remote)
 - Distributed I/O: up to 64x TM3 I/O bus coupler (EtherNet/IP) and/or up to 32x TM3 I/O bus coupler (Modbus/TCP) (2), allowing up to 14x TM3 I/O modules by bus coupler

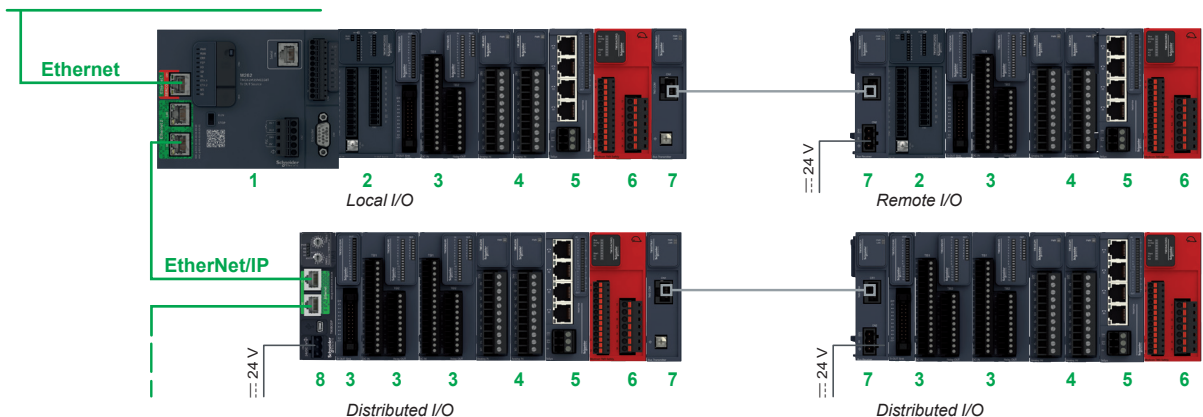

- 1 Modicon M262 Logic/Motion controller
- 2 TM3 Expert counter module (event management available on first two slots after M262 controller only)
- 3 TM3 Digital I/O modules
- 4 TM3 Analog I/O modules
- 5 TM3 Expert module for controlling TeSys motor starters
- 6 TM3 Functional safety modules
- 7 TM3 I/O bus expansion modules (transmitter and receiver) and bus expansion cable
- 8 TM3BCEIP bus coupler module (several bus coupler are allowed)

(1) For vertical or flat mounting, please consult our Customer Care Center.
 (2) With TM262L10MESE8T and TM262M15MESS8T: 64x TM3 I/O bus coupler (EtherNet/IP) and up to 16x TM3 I/O bus coupler (Modbus/TCP). With TM262L20MESE8, TM262M25MESS8T and TM262M35MESS8T: 64x TM3 I/O bus coupler (EtherNet/IP) and up to 32x TM3 I/O bus coupler (Modbus/TCP).



DIA3ED2140109EN

Modicon M262

Logic/Motion controller – I/O-ready for performance machines

Modicon M262 Logic/Motion controllers

Connecting a Modicon M262 controller to Modicon TM5 and Modicon TM7 I/O systems

- On the embedded Ethernet ports of the Modicon M262 Logic/Motion controller, to extend its capacity with distributed I/O systems that provide flexibility and scalability for machines:
 - With Modicon TM5, IP20 Performance range of I/O designed for complex machines
 - With Modicon TM7, IP67 Performance range of I/O designed to work in harsh environments

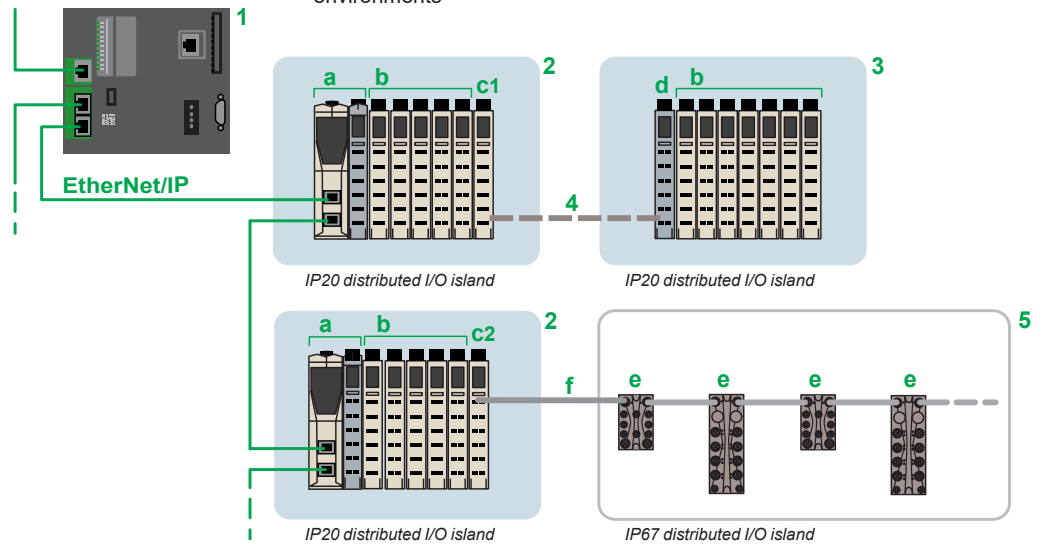

- Modicon M262 Logic/Motion controller: EtherNet/IP network masters
- TM5 EtherNet/IP interface module (slave) (a) + TM5 modules (b) + TM5SBET1 (c1)/TM5SBET7 (c2) transmitter modules
- TM5SBER2 receiver module (d) + TM5 I/O modules (b)
- TM5 expansion bus: TCSXCNNXN100 remote I/O connection cable
- TM7 blocks (digital or analog I/O) (e) + TM7TCSXC�E bus expansion cable (f)

Connecting a Modicon M262 Motion controller to Modicon TM5 and Modicon TM7 safety I/O systems

- On the embedded Sercos port of the Modicon M262 Motion controller: Embedded safety with the Modicon TM5CSLC safety logic controller, Modicon TM5 safety I/O and Modicon TM7 safety I/O.

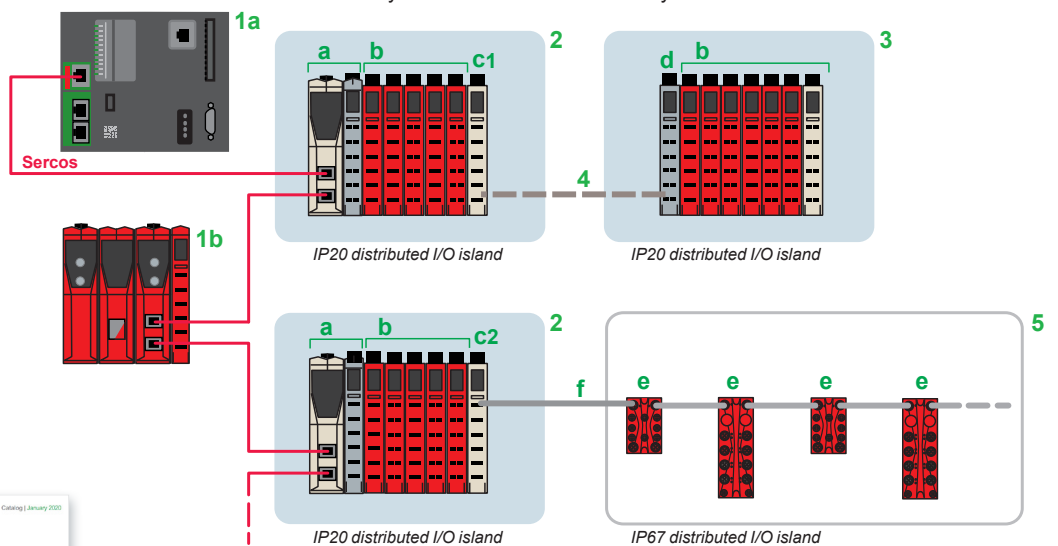

- Modicon M262 Motion controller: Sercos bus master
 - TM5CSLC safety logic controller: Sercos bus slave
- TM5 interface module (a) + TM5 safety I/O modules (b) + TM5SBET1 (c1)/TM5SBET7 (c2) transmitter modules
- TM5SBER2 receiver module (d) + TM5 safety I/O modules (b)
- TM5 expansion bus: TCSXCNNXN100 remote I/O connection cable
- TM7 safety I/O blocks (e) + TM7TCSXC�E bus expansion cable (f)



DIA3ED2131204EN

DIA3ED2140405EN

Modicon M262

Logic/Motion controller – IIoT-ready for performance machines

Embedded communication

Embedded communication

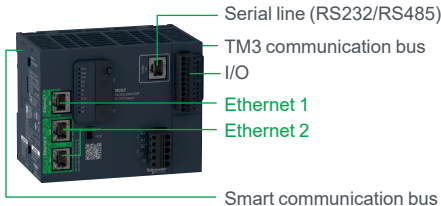

Modicon M262 Logic controller

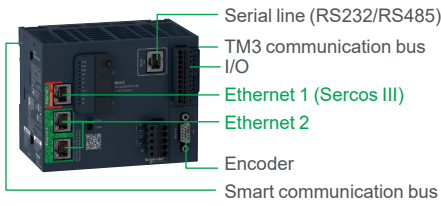

Modicon M262 Motion controller

- > Modicon M262 Logic/Motion controllers embed:
 - Two Ethernet-based networks:
 - Ethernet 1 with one RJ45 connector: 100 Mbit/s with EtherNet/IP, Modbus/TCP; plus Sercos III on motion controllers
 - Ethernet 2 with 2x RJ45 connectors: 1 Gbit/s with EtherNet/IP, Modbus/TCP allowing RSTP (1) ring topology and Service Ethernet RSTP (1)
 - One isolated serial port with one RJ45, 0.3 to 115 kBauds, RS232 or RS485, with Modbus, ASCII and Machine Expert protocols
 - One smart communication bus, for TMS smart communication modules (Ethernet and CANopen)
 - One TM3 communication bus
 - One I/O port
- > Modicon M262 Motion controllers embed one encoder connector for SSI incremental or absolute encoders, VW3M4701 cable can be used (to be ordered separately, see [page 19](#)).

Ethernet services

Available services on Modicon M262 Logic/Motion controllers and on the Ethernet smart communication module

Communication type	Protocol	Service	
IP	TCP/UDP	MQTT Client (Sign and Encrypt)	
		OPC UA Client (Sign and encrypt) (on TM262L20MESE8T, TM262M25MESS8T, TM262M35MESS8T)	
		OPC UA Server (Sign and Encrypt)	
		HTTPs Method (API)	
		TLS 1.2 (Encryption)	
		DHCP Client (Dynamic Host Configuration Protocol)	
		DHCP Server	
		DNS Client (Domain Name System)	
		POP3s Client (Receive email) (Post Office Protocol)	
		RSTP - Ring Topology (Rapid Spanning Tree Protocol)	
		SMTPs Client (Send email) (Simple Mail Transfer Protocol)	
		SNMP Agent (Simple Network Management Protocol)	
		SNMP Manager	
		SNTP (Simple Network Time Protol)	
		SQL Remote access	
		WebServer including Machine Assistant (Commissioning and Maintenance)	
		WebVisu (Customizable pages)	
		EtherNet/IP	Adapter
			Scanner
		Modbus TCP	Client
IO Scanner			
Server			
	NVL (Network Variable List)		
Machine Expert protocol	Symbol configuration		
FTP	FTP Client (File Transfer Protocol)		
	FTP's Server		
Sercos	Sercos III Master (on M262 Motion controller)		
Serial	CANopen	Master	
Serial - RS485 or RS232	Modbus SL (ASCII or RTU)	Master	
		IO Scanner	
		Slave	
		Modem Management	
		Modem Management	
ASCII	ASCII Manager		
	Modem Management		
Machine Expert protocol	Symbol configuration		
	Modem Management		

Note: All protocols and services may not be available at the same time, please check with the [User Guide](#) or consult Schneider Electric support.

For Ethernet cables and accessories, please consult our catalog ref. [DIA3ED2160105EN](#).

(1) Rapid Spanning Tree Protocol.

Modicon M262

Logic/Motion controller – IIoT-ready for performance machines

Additional communication, Embedded safety

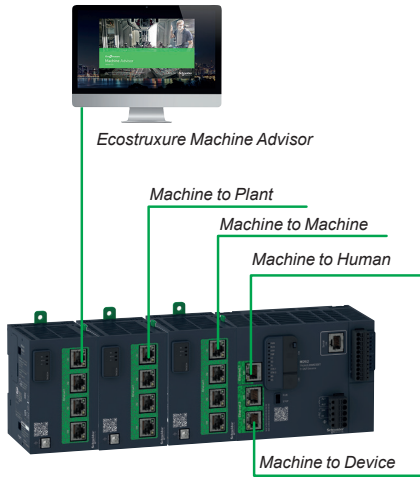

Modicon M262 logic controller with 3x TMSES4 smart communication modules (maximum configuration)

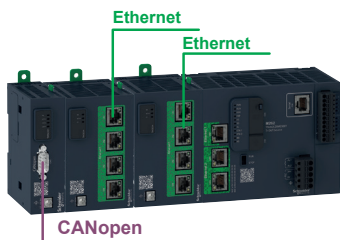

Modicon M262 logic controller with 3 smart communication modules: TMSES4 and TMSCO1 (always the last module on the left): Maximum configuration with CANopen



Modicon TM262M controlling TM5CSLC safety logic controller, TM5 safety I/O modules and TM7 safety I/O blocks on Sercos III

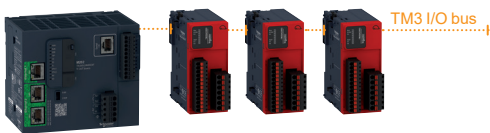

Modicon M262 Logic/Motion controller controlling TM3 functional safety modules: local I/O connected to the TM3 I/O bus

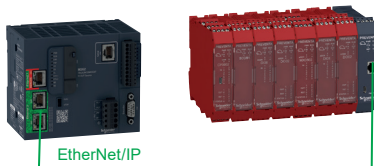

Modicon M262 Motion controller controlling Preventa XPSMCM modular safety controllers on Ethernet network

Additional communication

With the use of smart communication modules, the controllers benefit from optional connections:

- One CANopen connection
 - Up to three Ethernet connections
- > **TMSCO1** smart communication module - adds a CANopen port for CANopen master communication.
- The link can be configured between 20 kbps and 1 Mbit/s and supports up to 63 slaves.
 - Architectures based on CANopen are used to distribute I/O modules as close to the sensors and actuators as possible, thus reducing wiring costs and times and to communicate with different devices such as variable speed drives, servo drives, etc.
 - The CANopen configurator is integrated in the EcoStruxure Machine Expert software and can also be used to import standard description files in EDS format.
 - For CANopen connection cables and accessories, please consult our catalog ref. [DIA3ED2160104EN](#).
- > **TMSES4** smart communication module - allows up to 3 additional Ethernet networks:
- 4x RJ45 switched ports as hub
 - IIoT-ready
 - Network isolation
 - Ethernet Gigabyte exchange

Certifications and standards

- > TMS smart communication modules meet the requirements of the following certifications: CE, cULus HazLoc, RCM, EAC, EU RO Mutual (Marine certification) (1)
- > TMS smart communication modules conform to the following standards:
- UL 61010-1, UL 61010-2-201
 - CSA C22.2 No. 61010-1, CSA C22.2 No. 61010-2-201, CSA C22.2 No. 213
 - ANSI/ISA 12-12-01
 - EN 61131-2

Embedded safety

Modicon TM5CSLC safety logic controller

- > Modicon TM262M Motion controllers embed the Sercos protocol on their Ethernet 1 port, so that they can manage Modicon TM5CSLC safety logic controllers, set as slave on Sercos, Modicon TM5 safety I/O modules and Modicon TM7 safety I/O blocks.

Modicon TM3 functional safety modules

- > Modicon M262 Logic/Motion controllers embed a TM3 I/O bus for managing Modicon TM3 functional safety modules, locally, in remote or distributed..

Safety offers by Schneider electric

- > Preventa XPSMCM modular safety controllers on EtherNet/IP network (or Modbus RTU, Modbus/TCP, EtherCat, CANopen and ProfibusDP fieldbus)

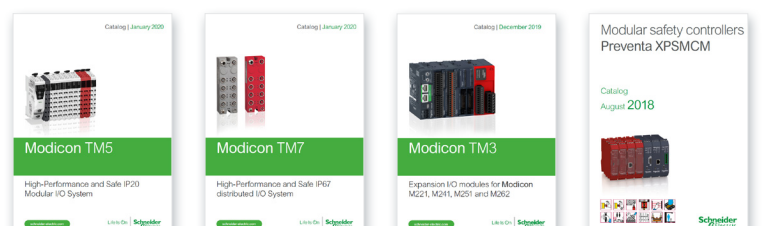

[DIA3ED2131204EN](#) [DIA3ED2140405EN](#) [DIA3ED2140109EN](#) [DIA3ED2140901EN](#)

(1) Pending..

Modicon M262

Logic/Motion controller – IIoT-ready for performance machines

Modicon M262 controllers

Applications	Logic control		Motion control		
					
Embedded I/O	4 fast digital inputs 4 fast digital outputs	4 fast digital inputs 4 fast digital outputs	4 fast digital inputs 4 fast digital outputs	4 fast digital inputs 4 fast digital outputs	4 fast digital inputs 4 fast digital outputs
Encoder input	–	–	Incremental/SSI, 5 VDC/24 VDC	Incremental/SSI, 5 VDC/24 VDC	Incremental/SSI, 5 VDC/24 VDC
Synchronized axes	–	–	4 (1 ms)	8 (2 ms)	16 (2 ms)
Performance	5 ns/inst	3 ns/inst	5 ns/inst	3 ns/inst	3 ns/inst
Certifications	CE, cULus HazLoc, RCM, EAC, Achilles L2, EU RO Mutual (Marine certification) (1)		CE, cULus HazLoc, RCM, EAC, Achilles L2, EU RO Mutual (Marine certification) (1)		
Standards	UL 61010-1, -2-201 CSA C22.2 No. 61010-1, CSA C22.2 No. 61010-2-201, CSA C22.2 No. 213 ANSI/ISA 12-12-01 EN 61131-2		UL 61010-1, -2-201 CSA C22.2 No. 61010-1, CSA C22.2 No. 61010-2-201, CSA C22.2 No. 213 ANSI/ISA 12-12-01 EN 61131-2		
Ambient air temperature for operation	<ul style="list-style-type: none"> > Horizontal mounting: - 20 °C...60 °C (-4...140 °F) > Vertical mounting: - 20 °C...50 °C (-4...122 °F) > Flat mounting: - 20 °C...45 °C (-4...113 °F) 		<ul style="list-style-type: none"> > Horizontal mounting: - 20 °C...60 °C (-4...140 °F) > Vertical mounting: - 20 °C...50 °C (-4...122 °F) > Flat mounting: - 20 °C...45 °C (-4...113 °F) 		
Embedded communication	<ul style="list-style-type: none"> > Ethernet 1 with one RJ45 port : 100 Mbit/s with EtherNet/IP and Modbus/TCP > Ethernet 2 with two RJ45 ports: 1 Gbit/s with EtherNet/IP Modbus/TCP and Service Ethernet RSTP (Rapid Spanning Tree Protocol) 		<ul style="list-style-type: none"> > Ethernet 1 with one RJ45 port : 100 Mbit/s with EtherNet/IP, Modbus/TCP and Sercos III > Ethernet 2 with two RJ45 ports: 1 G bit/s with EtherNet/IP, Modbus/TCP and Service Ethernet RSTP (Rapid Spanning Tree Protocol) 		
Services	Scanner manager on EtherNet/IP and Modbus/TCP, EtherNet/IP Adapter, DHCP Client/Server, Data exchange - IEC VAR ACCESS, Modbus/TCP Client/Server, Modbus/TCP Client device, SNMP Client/Server, FTP Client/Server, Web server and Web visu, SQL Client, Send/receive email based on TCP/UDP Library, Web server, OPC UA Server, DNS Client, MQTT, HTTP, SNTP, TLS, Machine Assistant, OPC UA Client (only on TM262L20MESE8T)		Scanner manager on EtherNet/IP and Modbus/TCP, EtherNet/IP Adapter, DHCP Client/Server, Data exchange - IEC VAR ACCESS, Modbus/TCP Client/Server, Modbus/TCP Client device, SNMP Client/Server, FTP Client/Server, Web server and Web visu, SQL Client, Send/receive email based on TCP/UDP Library, Web server, OPC UA Server, DNS Client, MQTT, HTTP, SNTP, TLS, Machine Assistant, OPC UA Client (only on TM262M25MESS8T and TM262M35MESS8T)		
USB	1x USB Mini-B isolated (programming, virtual port, FTP, HTTP, Modbus)		1x USB Mini-B isolated (programming, virtual port, FTP, HTTP, Modbus)		
Memory card	Secure Digital card (SD up to 2 GB or SDHC up to 32 GB)		Secure Digital card (SD up to 2 GB or SDHC up to 32 GB)		
Serial line	One isolated serial link (RJ45): RS232 or RS485 (configurable), with RTU, Modbus SL, ASCII and Machine Expert protocols		One isolated serial link (RJ45): RS232 or RS485 (configurable), with RTU, Modbus SL, ASCII and Machine Expert protocols		
Additional communication	Up to three additional Ethernet networks (EtherNet/IP Adapter and Modbus/TCP Server) with TMSES4 Smart communication module: <ul style="list-style-type: none"> - 4 switched RJ45 ports as hub - IIoT-ready - Network isolation with management from M262 - Ethernet Gigabyte exchange 		Up to three additional Ethernet networks (EtherNet/IP Adapter and Modbus/TCP Server) with TMSES4 Smart communication module: <ul style="list-style-type: none"> - 4 switched RJ45 ports as hub - IIoT-ready - Network isolation with management from M262 - Ethernet Gigabyte exchange 		
CANopen	One CANopen port for CANopen master communication with TMSCO1 smart communication module		One CANopen port for CANopen master communication with TMSCO1 smart communication module		
Compatible I/O systems	<ul style="list-style-type: none"> > Modicon TM3 (2): <ul style="list-style-type: none"> - Expert modules (upcounting, downcounting, allow event (TM3XFHSC) on 2 first slots) - Analog modules - Digital modules - Embedded safety with TM3 functional safety modules > Modicon TM3 Ethernet bus coupler (2) > Modicon TM5 Ethernet network interface module (3) 		<ul style="list-style-type: none"> > Modicon TM3 (2): <ul style="list-style-type: none"> - Expert modules (upcounting, downcounting, allow event (TM3XFHSC) on 2 first slots) - Analog modules - Digital modules - Embedded safety with TM3 functional safety modules > Modicon TM3 Ethernet bus coupler (2) > Modicon TM5 Ethernet network interface module (3) 		
For distributed I/O on Ethernet network	–		<ul style="list-style-type: none"> > Modicon TM5 Sercos bus interface module (3), Embedded safety with TM5CSLC safety logic controllers, Modicon TM5 safety I/O modules 		
on Sercos bus	–		<ul style="list-style-type: none"> > Modicon TM7 safety I/O blocks (4) 		
on CANopen bus	<ul style="list-style-type: none"> > Modicon TM3 CANopen bus coupler (2) > Modicon TM5 CANopen bus interface module (3) > Modicon TM7 CANopen interface block (4) 		<ul style="list-style-type: none"> > Modicon TM3 CANopen bus coupler (2) > Modicon TM5 CANopen bus interface module (3) > Modicon TM7 CANopen interface block (4) 		
Configuration software	EcoStruxure Machine Expert software (5)		EcoStruxure Machine Expert software (5)		
Type of controller	TM262L10MESE8T	TM262L20MESE8T	TM262M15MESS8T	TM262M25MESS8T	TM262M35MESS8T
Page	19		19		

(1) Pending.
 (2) Consult catalog ref. [DIA3ED2140109EN](#).
 (3) Consult catalog ref. [DIA3ED2131204EN](#).
 (4) Consult catalog ref. [DIA3ED2140405EN](#).
 (5) Consult catalog ref. [DIA3ED2180701EN](#).

Description

Modicon M262

Logic/Motion controller – IIoT-ready for performance machines

Modicon M262 controllers, TMS smart communication modules

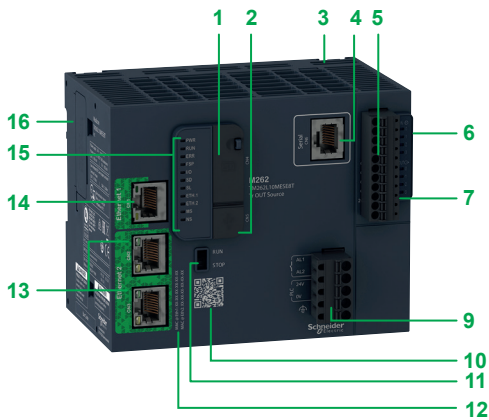

Modicon M262 Logic controller

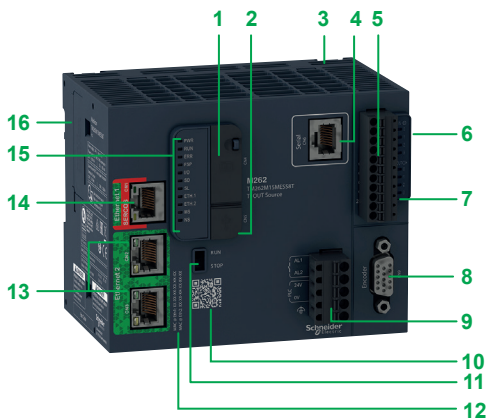

Modicon M262 Motion controller

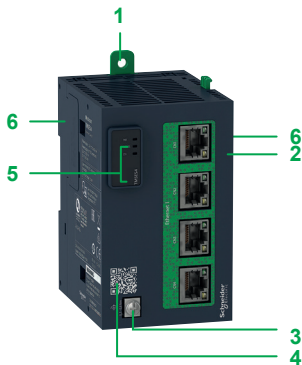

TMS4 Ethernet smart communication module

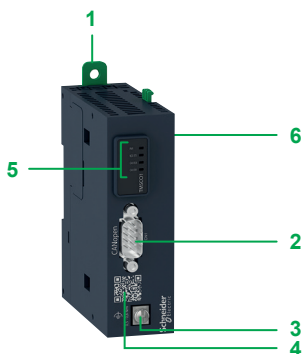

TMS1 CANopen smart communication module

Description

Modicon M262 controllers (1)

- 1 SD card slot marked CN4 (behind a protective cover)
- 2 USB Mini-B programming port marked CN5 (behind a protective cover)
- 3 Clip-on lock for 35 mm (1.38 in.) DIN rail
- 4 RJ45 port marked CN6 for Serial line
- 5 Removable spring terminal connector marked CN8 for inputs/outputs (1)
- 6 On right side of the controller: TM3 I/O bus connector
- 7 I/O status LEDs
- 8 On TM262M: type Sub-D 15-way connector marked CN9 for encoder
- 9 Removable spring terminal connector marked CN7 (provided with the controller) for 24 VDC power supply input/alarm relay (1)
- 10 QR code: link to SE product maintenance page and unique serial number (S/N)
- 11 Run/Stop switch (with relief protecting unsolicited switching)
- 12 MAC addresses written on Modicon M262 front face
- 13 2x Ethernet switched ports (type RJ45) marked Eth2 (CN2 and CN3)
- 14 On TM262L●●● Logic controllers: 1 Ethernet port (type RJ45) marked Eth1 (CN1)
On TM262M●●● Motion controllers: 1 Ethernet/Sercos port (type RJ45) marked Eth1 (CN1)
- 15 Status LEDs
- 16 On left side of controller: smart communication bus connector

TMS smart communication modules

- 1 Clip-on lock for 35 mm (1.38 in.) DIN rail
- 2 On TMS4: 4x Ethernet switched ports, type RJ45 (10 BASE-T -100-1000 BASE-TX)
On TMS1: 1 CANopen port, type Sub-D 9-way
- 3 Functional ground connector
- 4 QR code: link to SE product maintenance page and unique serial number (S/N)
- 5 Status LEDs
- 6 Smart communication bus connector:
 - on both sides of TMS4 Ethernet smart communication module
 - on right side of TMS1 CANopen smart communication module only

(1) Modicon M262 controllers are supplied with removable spring terminal blocks for connecting the I/O and power supply.

Note: It is advisable to use the TM2XMTGB grounding plate, which simplifies connection of the analog sensor and actuator cable shielding. This shielding must be connected to the device's functional ground.

Modicon M262

Logic/Motion controller – IIoT-ready for performance machines

Modicon M262 controllers, TMS smart communication modules



TM262L10MESE8T



TM262M15MESS8T



TMSES4



TMSCO1



TMA262SET8S



TMA262SET8G



TMAM3



TM2XMTGB

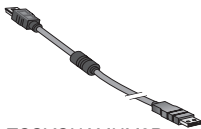

TCSXCNAMUM3P



[DIA3ED2140109EN](#)



[DIA3ED2131204EN](#)



[DIA3ED2140405EN](#)



[DIA3ED2180701EN](#)

References

Modicon M262 controllers (1) 24 V $\overline{\text{DC}}$ power supply

I/O	Execution speed ns/Boolean instructions	Max. no. of synchronized axes	Embedded communication (2)			Reference	Weight kg/lb
			Ethernet	Sercos	Serial link		
Logic controllers	4 fast digital inputs/4 fast digital outputs	5	–	2	–	1	TM262L10MESE8T 0.665 1.466
		3	–	2 (3)	–	1	TM262L20MESE8T 0.665 1.466

Motion controllers

4 fast digital inputs/4 fast digital outputs + 1 encoder input (incremental/SSI, 5 VDC/24 VDC)	5	4 axes	2	1	1	TM262M15MESS8T	0.670 1.477
	3	8 axes	2 (3)	1	1	TM262M25MESS8T	0.670 1.477
	3	16 axes	2 (3)	1	1	TM262M35MESS8T	0.670 1.477

TMS smart communication modules for Modicon M262 controllers

Designation	Description	Reference	Weight kg/lb
Ethernet smart communication module	For adding an Ethernet network Equipped with 4x RJ45 switched ports: - IIoT-ready - Network isolation - Ethernet Gigabyte exchange	TMSES4	0.403 0.888
CANopen smart communication module	For adding a CANopen master network Equipped with a 9-way SUB-D connector	TMSCO1	0.150 0.330

Spare parts for Modicon M262 controllers

Designation	Description	Reference	Weight kg/lb
Mounting kit	2 attachment parts to mount the controller and TMS modules directly to a flat, vertical panel	TMAM3	–
Set of screw terminal blocks	Connecting I/O and power supply	TMA262SET8S	0.030 0.066
Set of spring terminal blocks	Connecting I/O and power supply	TMA262SET8G	0.030 0.066

Accessories for Modicon M262 controllers

Designation	Description	Reference	Weight kg/lb
Secure Digital card	Application backup and program transfer Capacity: 256 MB	TMASD1	0.004/ 0.009
Grounding plate	Support equipped with 10 male Faston connectors for connecting the cable shielding (via 6.35 mm (0.25 in.) connectors, not supplied) and the functional ground (FG)	TM2XMTGB	0.045/ 0.099

Connection cables

Designation	Use from	to	Length m (ft)	Reference	Weight kg/lb
Programming cables	PC (USB port)	Modicon M262 controller (USB Mini-B port)	3 (0.98)	TCSXCNAMUM3P (4)	0.065/ 0.143
			1.8 (5.90)	BMXXCAUSBH018	0.065/ 0.143
Cable for master encoder input	Incremental or SSI serial absolute encoders (1 stripped end)	Modicon M262 Motion controller (Sub-D connector marked CN9)	1 (3.28)	VW3M4701	–

Expansion modules

Modicon TM3 I/O expansion modules	Please consult the catalog ref. DIA3ED2140109EN
Modicon TM5, High-Performance and Safe IP20 Modular I/O System	DIA3ED2131204EN
Modicon TM7, High-Performance and Safe IP67 Distributed I/O System	DIA3ED2140405EN

Programming software

EcoStruxure Machine Expert	Please consult the catalog ref. DIA3ED2180701EN
----------------------------	--

- (1) Modicon M262 controllers are supplied with removable spring terminal blocks for the I/O and power supply connections.
- (2) Ethernet embeds EtherNet/IP and Modbus/TCP, only one Master allowed, in combination with Sercos, Eth. 1 allows EtherNet/IP, Modbus/TCP, and Sercos on same port and cable (one-cable).
- (3) OPC UA Client service is available on this model with EcoStruxure Machine Expert.
- (4) Unshielded, non-grounded cable. For use on temporary connections only. For permanent connections, use cable reference BMXXCAUSBH018.

Modicon M262

Logic/Motion controller – IIoT-ready for performance machines

Modicon M262 Logic controller in a TVDA

Modicon M262 Logic controller

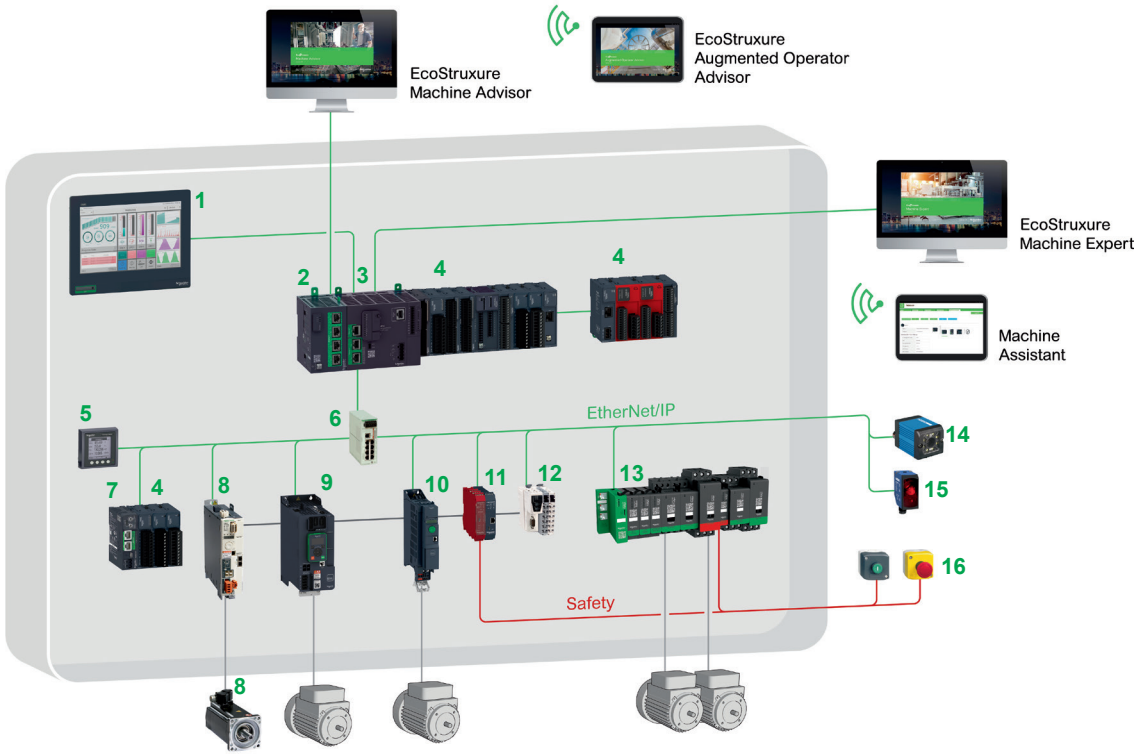

Solution breakdown
Refer to our catalogs on [Digi-Cat](#) (click to consult Digi-Cat)

- | | |
|---|--|
| <ul style="list-style-type: none"> 1 Harmony iPC: Touchscreen display (1) 2 Modicon TMSES4 Ethernet smart communication module 3 Modicon M262 Logic controller 4 Modicon TM3 expansion modules (digital, analog, Expert and safety I/O) 5 PowerLogic Power Meter 6 Ethernet Switch 7 Modicon TM3 Ethernet bus coupler 8 Lexium 32 servo drive and BMH/BSH servo motor | <ul style="list-style-type: none"> 9 Altivar Machine ATV340 variable speed drive 10 Altivar Machine ATV320 variable speed drive 11 Preventa XPSMCM modular safety controller 12 Modicon TM5 Ethernet interface module 13 TeSys island Digital multifunctional load management solution 14 Telemecanique Vision sensor 15 Telemecanique Photoelectric Sensors 16 Harmony® XB5 plastic pushbutton and Emergency stop |
|---|--|

(1) Formerly named as iPC.

Modicon M262

Logic/Motion controller – IIoT-ready for performance machines

Modicon M262 Motion controller in a TVDA

Modicon M262 Motion controller in a Tested Validated & Documented Architecture (TVDA)

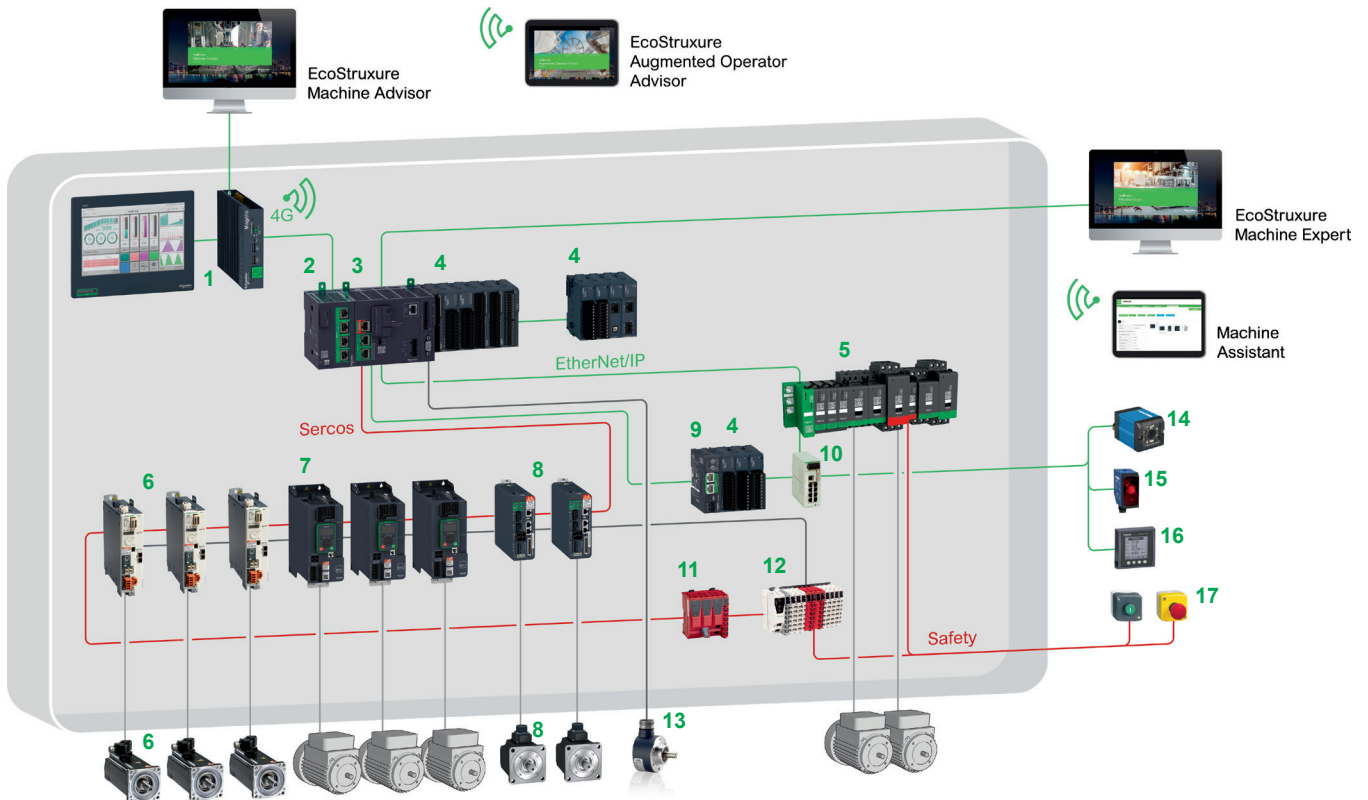

Solution breakdown

Refer to our catalogs on [Digi-Cat](#) (click to consult Digi-Cat)

- | | |
|--|---|
| <ul style="list-style-type: none"> 1 Harmony iPC: Touchscreen display and IIoT Edge Box (1) 2 Modicon TMSES4 smart communication module 3 Modicon M262 Motion controller 4 Modicon TM3 expansion modules (digital, analog and Expert I/O) 5 TeSys island Digital multifunctional load management solution 6 Lexium 32S servo drives and BMH/BSH servo motors 7 Altivar Machine ATV340 variable speed drives 8 Lexium 28 servo drives and BCH2 servo motors 9 Modicon TM3 Ethernet bus coupler | <ul style="list-style-type: none"> 10 Ethernet Switch 11 Modicon TM5CSLC safety logic controller 12 Modicon TM5: Sercos interface module and I/O modules (digital, analog and safety I/O) 13 Encoders 14 Telemecanique Vision sensor 15 Telemecanique Photoelectric Sensors 16 PowerLogic Power Meter 17 Harmony® XB5 plastic pushbutton and Emergency stop |
|--|---|

(1) Formerly named as iPC.

B	
BMXXCAUSBH018	17
T	
TCSXCNAMUM3P	17
TM262L10MESE8T	17
TM262L20MESE8T	17
TM262M15MESS8T	17
TM262M25MESS8T	17
TM262M35MESS8T	17
TM2XMTGB	17
TMA262SET8G	17
TMA262SET8S	17
TMAM3	17
TMASD1	17
TMSCO1	17
TMSES4	17
V	
VW3M4701	17

Life Is On



Learn more about our products at
www.schneider-electric.com

The information provided in this documentation contains general descriptions and/or technical characteristics of the performance of the products contained herein. This documentation is not intended as a substitute for and is not to be used for determining suitability or reliability of these products for specific user applications. It is the duty of any such user or integrator to perform the appropriate and complete risk analysis, evaluation and testing of the products with respect to the relevant specific application or use thereof. Neither Schneider Electric nor any of its affiliates or subsidiaries shall be responsible or liable for misuse of the information contained herein.

Design: Schneider Electric
Photos: Schneider Electric

Schneider Electric Industries SAS

Head Office
35, rue Joseph Monier - CS 30323
F-92500 Rueil-Malmaison Cedex
France

DIA3ED2180503EN
July 2020 - V2.0